

Cat. No. N106-E1-1

K3MA Series Digital Panel Meter

USER MANUAL

OMRON

PREFACE

This User's Manual provides you with information necessary.

For use of the K3MA series of digital panel meters.

Please read this manual carefully to ensure correct and efficient use of the product.

Keep this manual handy for future reference.

GENERAL PRECAUTIONS

If contemplating using the product in the following environments or for the following equipment, first contact a sales representative of the company and then accept responsibility for incorporating into the design fail-safe operation, redundancy, and other appropriate measures for ensuring reliability and safety of the equipment and the overall system.

- (1) Environments deviating from those specified in this manual
- (2) Nuclear power control system, traffic (rail car/automobile/aircraft) control system, medical equipment, amusement equipment, and rescue and security equipment
- (3) Other equipment that demands high reliability, including those related to the safety of life and property

About the Content of the Manual

- (1) Any reproduction, full or in part, of the manual is prohibited without prior written permission from the company.
- (2) Descriptions in the manual may be subject to change without notice.
- (3) Information in the manual has been carefully checked for accuracy. If finding any suspicious or erroneous descriptions in the manual, however, you are kindly requested to contact a branch office of the company. In such a case, please let us know the Cat. No. shown on the front cover of the manual.

SAFETY PRECAUTIONS

● Signal Words

In this manual, safety notices are divided into WARNING and CAUTION according to the hazard level. As both of WARNING and CAUTION notices contain important information for ensuring safety, be sure to observe them.

 **WARNING**

A signal word indicating a potentially hazardous situation which, if not avoided, may result in death or serious injury.

 **CAUTION**

A signal word indicating a potentially hazardous situation, if not avoided, may result in minor or moderate injury or property damage.

● Warnings

 **CAUTION**

Do not touch live terminals of the product.
Doing so may result in electrical shock.

Do not disassemble or touch the inside when the power is turned on.
Doing so may result in electrical shock.

Do not allow pieces of metal or wire clippings to enter the product.
Doing so may result in electrical shock, fire, or malfunction.

Perform correct setting of the product according to the application. Failure to do so may cause unexpected operation of the overall system, resulting in damage to the system or personal injury.

Take appropriate safety measures in case the product malfunctions.
Otherwise, a serious accident could occur if a malfunction of the product prevents comparative output from being generated.

NOTICE

- **Observe the following precautions to ensure safety.**

- (1) Maintain the power supply voltage within specifications.
- (2) Use the product within the rated load.
- (3) Be sure to check each terminal for correct number and polarity before connection.
Incorrect or reverse connection may damage or burn out internal components of the product.
- (4) Be sure to tighten the terminal screws.
Recommended tightening torque: 0.43-0.58 N·m
Loose screws may result in product failure or malfunction.
- (5) Do not connect anything to unused terminals.
- (6) Install a switch or a circuit breaker so that the operator can turn off the power supply without delay and attach an appropriate label.
- (7) Do not disassemble, repair, or modify the product.
- (8) Do not use the product in flammable or explosive atmosphere.

- **For proper usage of the product:**

- (1) Do not use the product in such an environment that is subject to the following:
 - Direct heat radiation from any heat source
 - Water flooding or oil splashes
 - Direct sunlight
 - Dust or corrosive gases (especially, sulfuric or ammonia gas)
 - Rapid temperature changes
 - Condensation or icing due to high humidity
 - Strong vibration or mechanical shock
- (2) Do not block heat dissipation from the product, i.e., allow sufficient space for heat dissipation.
- (3) Be sure that the rated voltage is reached within 2 seconds after the power is turned ON.
- (4) Conduct aging for at least 15 minutes after turning ON the power for correct measurement.
(For K3MA-L: 30 minutes)
- (5) To prevent the effect of static electricity, do not touch live terminals or slit areas of the product.
- (6) Do not apply heavy load to the product. Doing so may deform or deteriorate the product.
- (7) Do not use paint thinner for cleaning. Use commercially available alcohol.

- **Installation and connection**

- (1) Mount the product to a panel that is 1 to 8 mm thick.
- (2) Install the product in a horizontal position.
- (3) Use crimp-style terminals fit for the screw size.

● **Noise prevention**

- (1) Install the product as far as possible from devices that generate strong high-frequency fields (such as high-frequency welders or sewing machines) or surges.
- (2) Attach surge absorbers or noise filters to nearby devices that generate noise (particularly, motors, transformers, solenoids, magnet coils, and other devices that have a high inductance component). However, in the case of K3MA-L, do not connect the surge absorber to the input unit for temperature sensors.

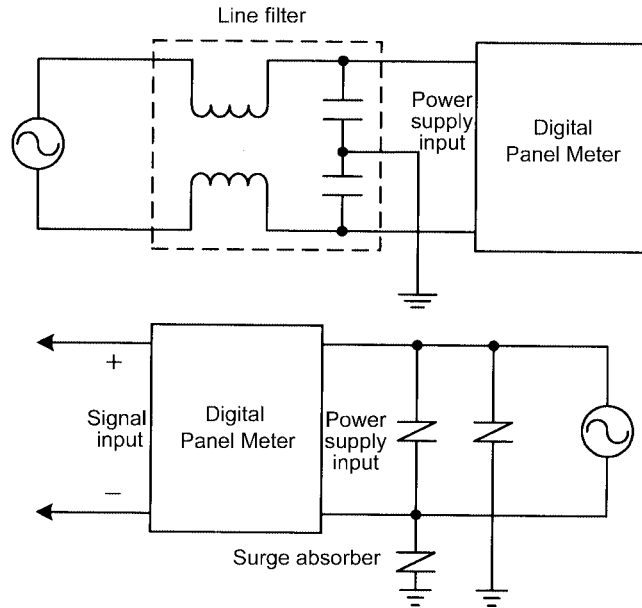

- (3) To prevent inductive noise, separate the terminal block wiring for the product from high-voltage or high-current power lines. Do not route the wiring for the product in parallel with or tie it in a bundle with power lines. Use of separate wiring ducts or shielded cables will also be effective for noise prevention.

<Examples of noise prevention schemes>

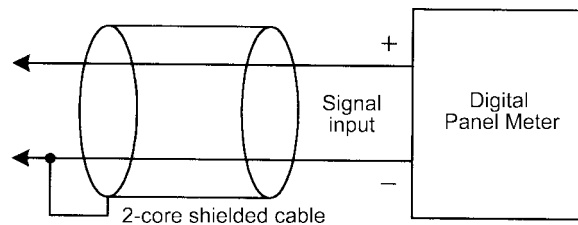

- (4) When using a power supply noise filter, check that the filter is suitable for the supply voltage and current ratings and then install it as close as possible to the product.
- (5) Televisions, radios, or other wireless devices may cause reception interference if placed near the product.

- **For usage of the product for a long time**

- (1) Avoid using the product in an area with temperature or humidity exceeding specifications, or subject to dew condensation.
When installing the product inside a panel, be sure that the temperature around the product (not the temperature around the panel) is within the specification.
The life of parts depends upon the ambient temperature. Higher temperature decreases and lower temperature increases the life of parts. Therefore, the life can be increased by lowering the inside temperature of the digital panel meter.
- (2) Use or store the product within the specified ambient temperature and humidity ranges.
If two or more products are installed close to each other or one is installed on top of another, the inside temperature of the products may be elevated due to heat generation by products themselves, resulting in decreased life of the products. In such cases, conduct forced cooling, for example, by using a fan to ventilate the product.
- (3) Since the life of output relay depends largely upon the capacity and condition of switching, be sure to take the actual conditions of usage into consideration and to use it within the rated load and the times of its electrical life.
Using it exceeding its life may cause welding of contact points or burning.

Alphabetic Characters for Setting Data

This manual uses the following alphabetic characters for setting data.

A	B	C	D	E	F	G	H	I	J	K	L	M
---	---	---	---	---	---	---	---	---	---	---	---	---

N	O	P	Q	R	S	T	U	V	W	X	Y	Z
---	---	---	---	---	---	---	---	---	---	---	---	---

Table of Contents

PREFACE	I
GENERAL PRECAUTIONS	I
SAFETY PRECAUTIONS	II
NOTICE	III
Alphabetic Characters for Setting Data	VI
Table of Contents	VII
CHAPTER 1 INTRODUCTION	1-1
1-1 Main Features of the K3MA	1-2
1-2 Model Number Legend	1-4
1-3 I/O Circuit	1-5
1-4 Parts Name and Function	1-7
CHAPTER 2 INSTALLATION AND CONNECTION	2-1
2-1 Installation	2-2
2-2 I/O Terminal Connections	2-4
CHAPTER 3 APPLICATION EXAMPLES	3-1
3-1 Monitoring the Liquid Level (K3MA-J)	3-2
3-2 Monitoring the Internal Pressure of a Tank (K3MA-J)	3-4
3-3 Monitoring the Temperature of an Industrial Furnace (K3MA-L)	3-6
3-4 Monitoring the Feed Speed of a Conveyer (K3MA-F)	3-8
3-5 Monitoring the Rotational Speed by Monitor Output of an Inverter (K3MA-F) ..	3-10
CHAPTER 4 INITIAL SETTING	4-1
4-1 K3MA-J (Process meter)	4-2
4-2 K3MA-L (Temperature meter)	4-4
4-3 K3MA-F (Frequency/Rate meter)	4-6
CHAPTER 5 OPERATION	5-1
5-1 Levels	5-2
5-2 Moving among Levels	5-3
5-3 Parameters	5-5
5-4 Set Values	5-6
5-5 Viewing and Changing OUT Set Values	5-7
5-6 Setting/Releasing the Forced-zero Operation (K3MA-J)	5-9
5-7 Displaying/Resetting the MAX/MIN Value	5-10
5-8 Specifying the Temperature Input Correction Value (K3MA-L)	5-11
5-9 Key Protect Setting	5-12
5-10 Selecting an Input Type (K3MA-J/K3MA-L)	5-14
5-11 Selecting an Input-pulse Frequency (K3MA-F)	5-16

5-12	Specifying the Scaling Factor (K3MA-J)	5-17
5-13	Specifying the Scaling Factor (K3MA-F)	5-19
5-14	Specifying the Decimal Point Position (K3MA-J/K3MA-F)	5-22
5-15	Specifying the Temperature Unit (K3MA-L)	5-23
5-16	Selecting a Comparative Output	5-24
5-17	Clearing All Parameters	5-25
5-18	Specifying the Number of Measurements for Averaging	5-26
5-19	Specifying the Hysteresis	5-27
5-20	Specifying the Auto-zero Time (K3MA-F)	5-28
5-21	Specifying the Start-up Compensation Time (K3MA-F)	5-30
5-22	Specifying the Zero-limit (K3MA-J)	5-31
5-23	Changing the Display Color	5-33
5-24	Changing the Display Auto-return Time	5-34
5-25	Changing the Move-to-Protect-Level Time	5-35
CHAPTER 6 FUNCTION DESCRIPTION		6-1
6-1	Measurement (K3MA-J)	6-2
6-2	Measurement (K3MA-L)	6-5
6-3	Measurement (K3MA-F)	6-6
6-4	Average Processing	6-10
6-5	Comparative Output	6-11
6-6	Hysteresis	6-12
6-7	Display Color Change	6-13
CHAPTER 7 TROUBLESHOOTING GUIDE		7-1
7-1	Indication of Error	7-2
7-2	Troubleshooting Table	7-3
APPENDIX		A-1
	Specifications	A-2
	Parameter List	A-3

CHAPTER 1

INTRODUCTION

This chapter provides an overview and parts name of the product.

1-1	Main Features of the K3MA	1-2
1-2	Model Number Legend	1-4
1-3	I/O Circuit	1-5
	Input Circuit Diagrams/Output Circuit Diagrams	
1-4	Parts Name and Function	1-7

1-1 Main Features of the K3MA

The K3MA is a digital panel meter that is capable of converting an input signal into a digital value and displaying it on the main indicator.

The main features of the product include the following.

Measurement This feature measures an input signal and displays it as a digital value.

The input signal to be measured by each type is as follows.

K3MA-J : Voltage/Current

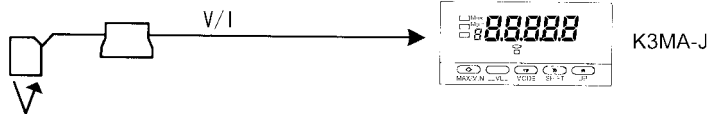

K3MA-L : Temperature



K3MA-F : Pulse signal



Scaling This feature converts an input signal into a desired physical value.

(Only K3MA-J/F) For example, when a pressure sensor is connected, in which a current range of 4-20 mA corresponds to a pressure range of 0-100 kPa, the readout for the input of 4 mA is converted into "0" and that for the input of 20 mA is converted into "100" (kPa). Since Scaling converts an input signal as a value of current into a unit (kPa) that is used in the system, it will enable you to get the value intuitively.

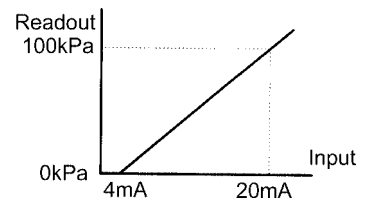

Comparative Output This feature compares a scaled value (measurement value) with a programmed OUT set value and produces output according to the comparison result.

This is useful in monitoring various systems for malfunction or determining whether products are within acceptance limits.

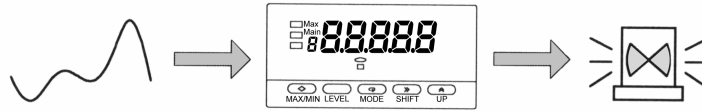

Three types of comparative outputs are available: those produced at the OUT upper-limit value, the OUT lower-limit value, and both the OUT values.

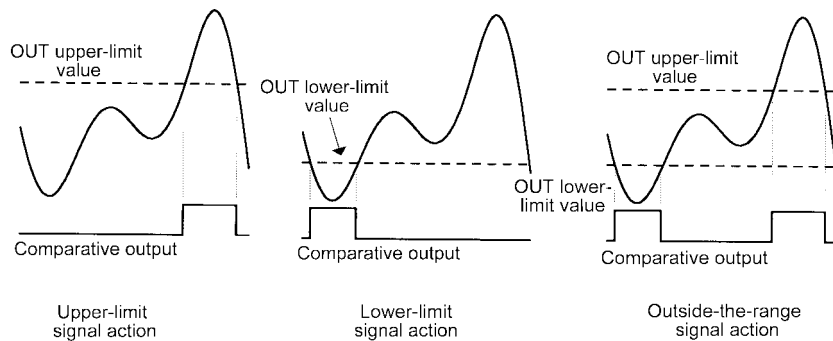

Forced-zero This feature shifts a process value to zero, and can be used to evaluate and display the deviation of a process value from a reference value.

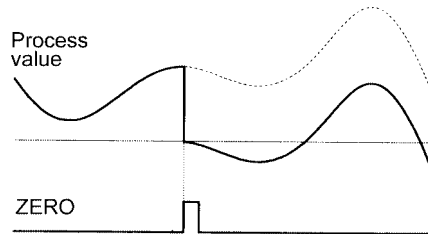

Display Color Change In the example shown below, the display color is programmed so that it changes from green to red when a comparative output turns ON. The display color can also be programmed so that it is fixed to "red" or "green".

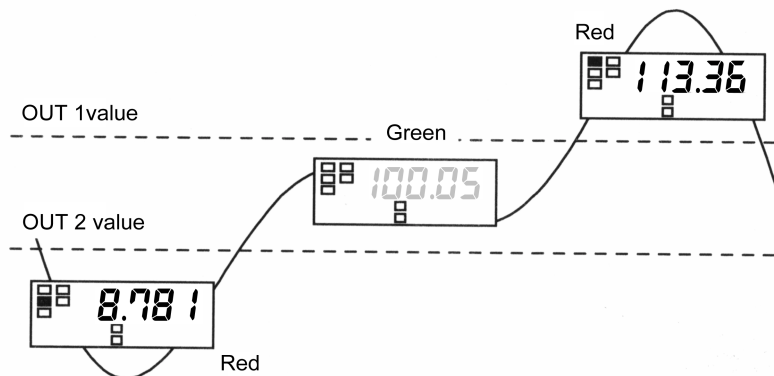

*As for K3MA-L, only one reference value can be set.

1-2 Model Number Legend

K3MA-□-□ AC100-240V

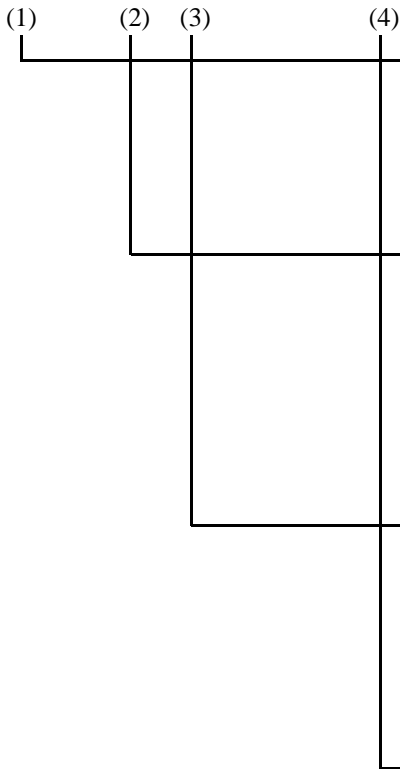

Model name

Symbol	Description
K3MA	Digital Panel Meter K3MA Series

Input type

Symbol	Description
J	DC voltage/Current input
L	Thermocouple/Resistance thermometer input
F	Pulse input

Output type

Symbol	Description
None	Not available
C	Relay contact output (1c)
A2	Relay contact output (1a × 2)

Power supply

Symbol	Description
AC100-240V	100 to 240 VAC (50/60 Hz)
AC/DC24V	24 VAC (50/60 Hz) 24 VDC (Non-polar)

1-3 I/O Circuit

Input Circuit Diagrams

Analog Input

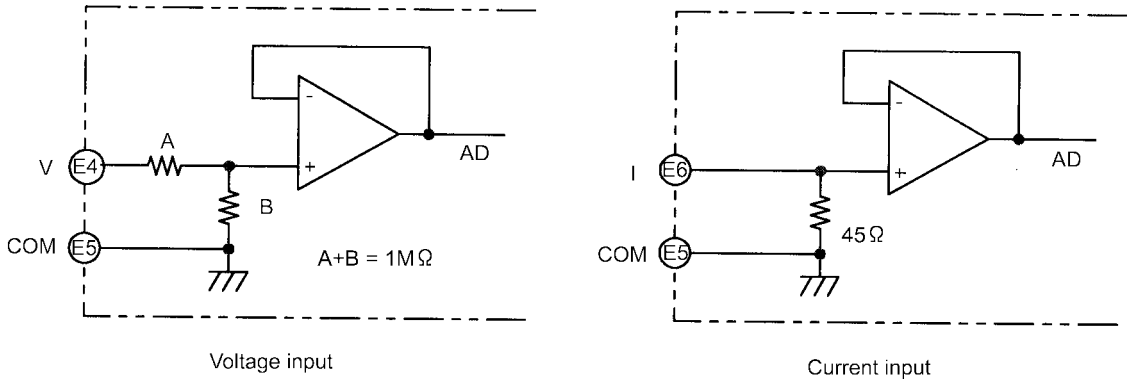

Pulse Input

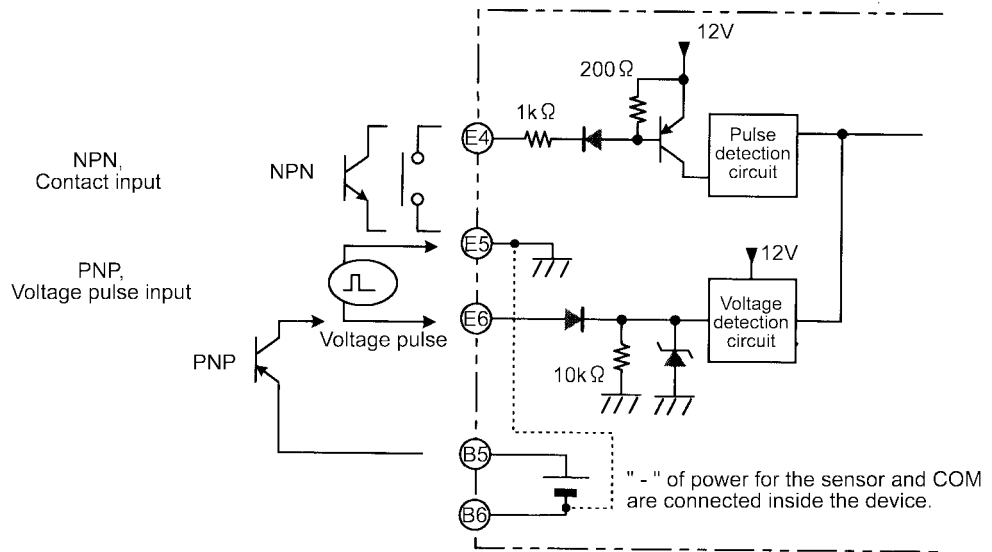

Output Circuit Diagrams

Contact Output

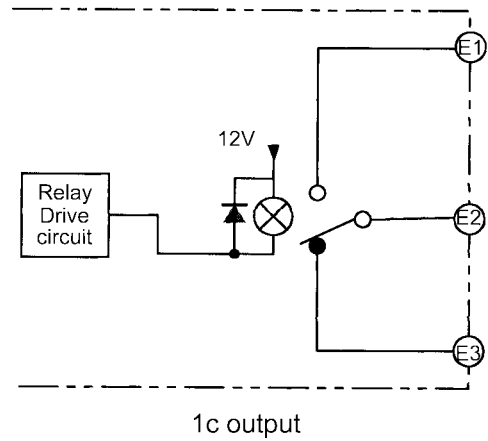
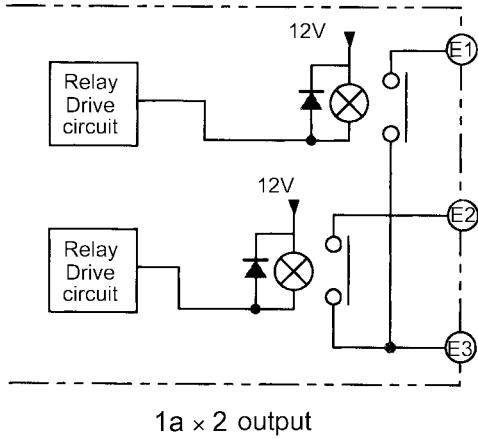

Internal Block Diagram

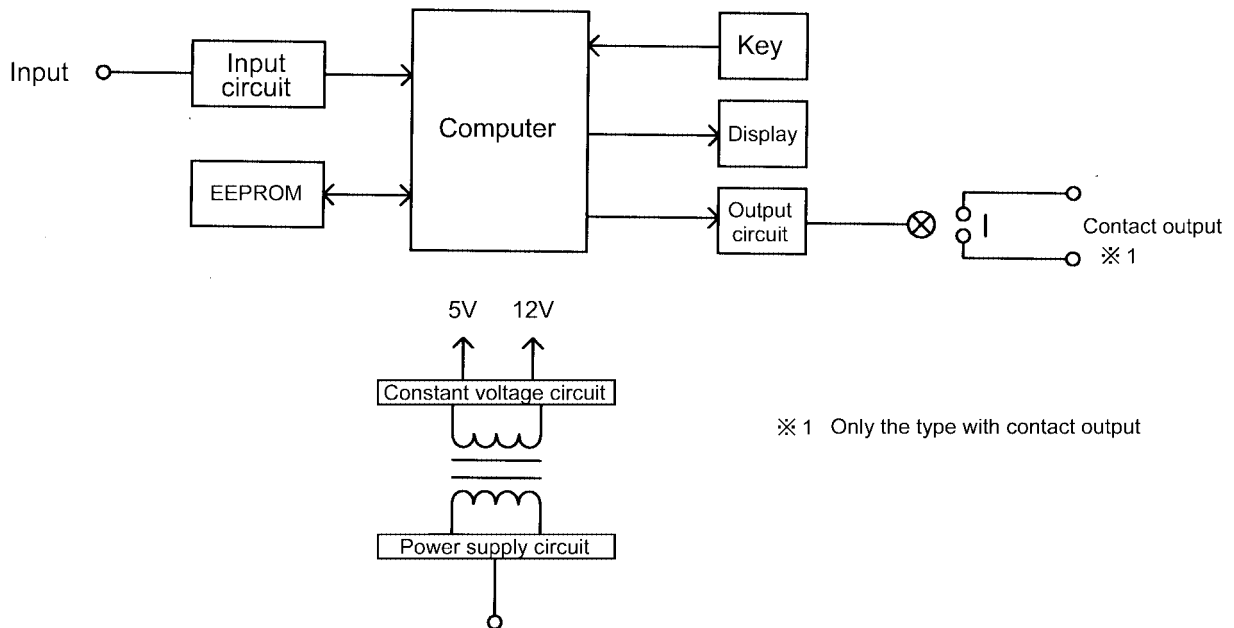

1-4 Parts Name and Function

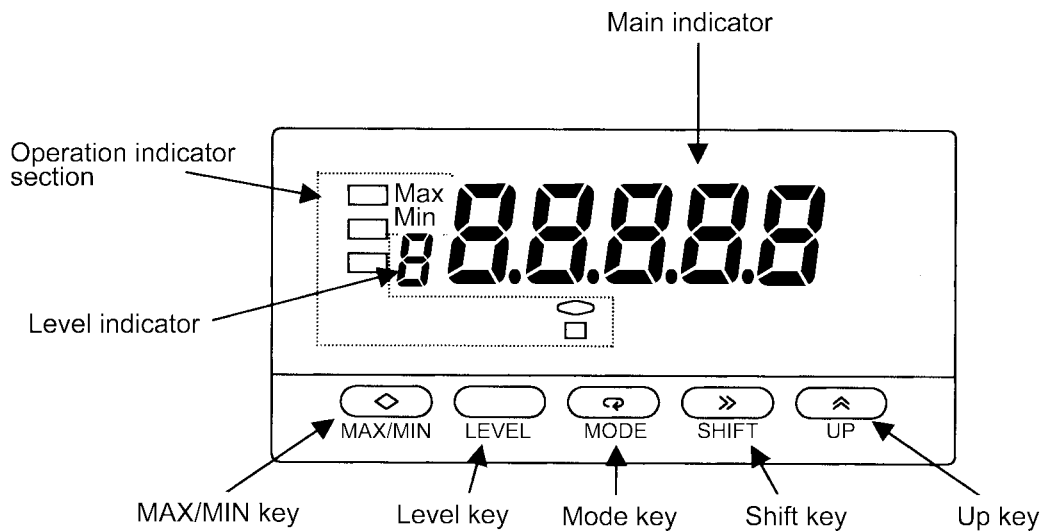

Name		Function
Main indicator		Displays a process value, parameter code, or set value.
Operation indicator sections	1 (Comparative output 1)	Is on when comparative output 1 is on, and off when comparative output 1 is off.
	2 (Comparative output 2)	Is on when comparative output 2 is on, and off when comparative output 2 is off. (Only K3MA-J/K3MA-F.)
	SV (Set value)	Stays on while a set value is displayed or being changed, and off at all other times.
	Max (MAX value)	Stays on while a MAX value is displayed, and off at all other times.
	Min (MIN value)	Stays on while a MIN value is displayed, and off at all other times.
	T (Teaching)	Stays on while a set value that can be taught is displayed, and blinks during teaching. Stays off at all other times. (Only K3MA-J/K3MA-F)
	Z (Forced-zero)	Is on when zero-shifting by forced-zero operation is active. Turns off when forced-zero operation is canceled. (Only K3MA-J)
Level indicator		Indicates the current level.
MAX/MIN key		Is used to select current value, MAX value, or MIN value for indication and to reset MAX/MIN value.
Level key		Is used to change one level to another.
Mode key		Is used to select a parameter to be displayed.
Shift key		Is used to check the set value of a parameter or enter the change state when the parameter is displayed. Is used to shift the figure of the set value when it is in the change state.
Up key		Is used to change the set value in the change state. Is used to execute or cancel the forced-zero operation when a process value is displayed. (Only K3MA-J)

CHAPTER 2

INSTALLATION AND CONNECTION

This chapter describes how to install and connect the product before turning the power on.

2-1	Installation	2-2
	Dimensions/Panel Cutout Dimensions/Installation Procedure/Visibility of LCD	
2-2	I/O Terminal Connections	2-4
	Terminal Arrangement /Terminal Connection	

2-1 Installation

■ Dimensions

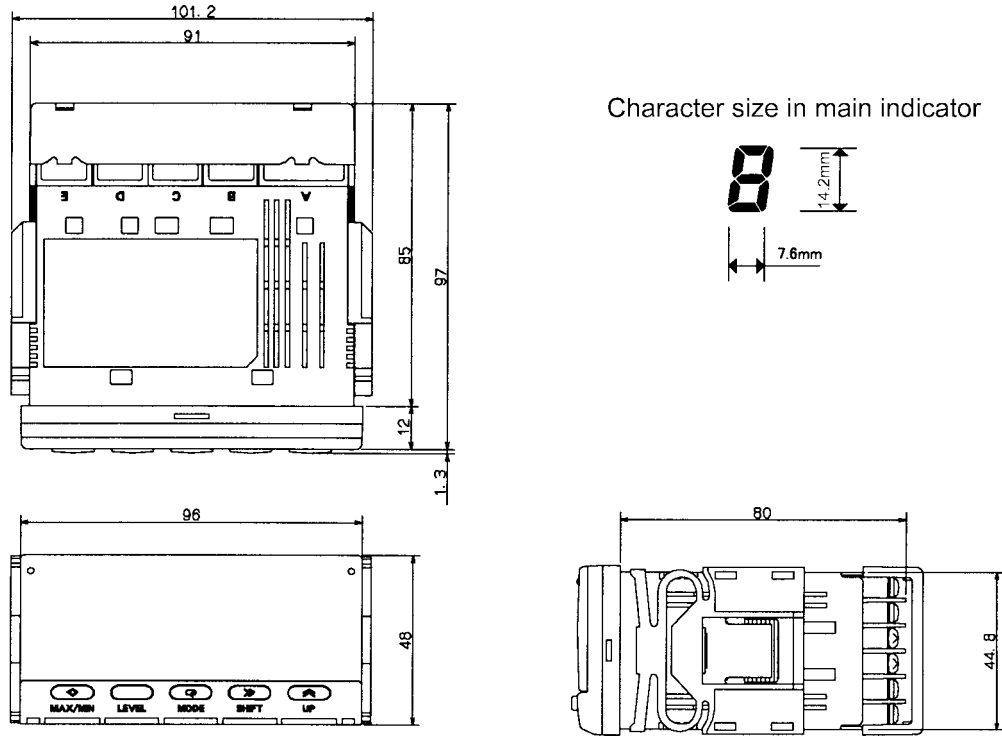

■ Panel Cutout Dimensions

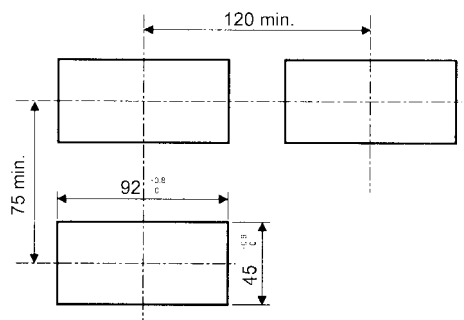

Fit the product into a rectangular panel cutout, put the adapter in the fixing grooves on the left and right surfaces of the rear case, and push the product until the gap between the product and the panel surface is minimized.

■ Installation Procedure

- (1) Fit the product into a rectangular panel cutout for installation.
- (2) If you want to make the product waterproof, insert a watertight packing in the product.

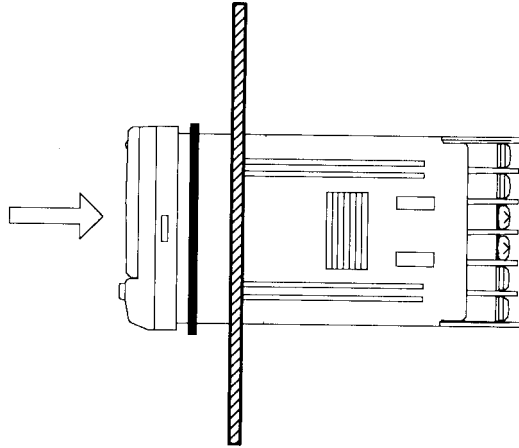

- (3) Put the adapter in the fixing grooves on the left and right surfaces of the rear case, push it until it contacts with the panel, and fix it.

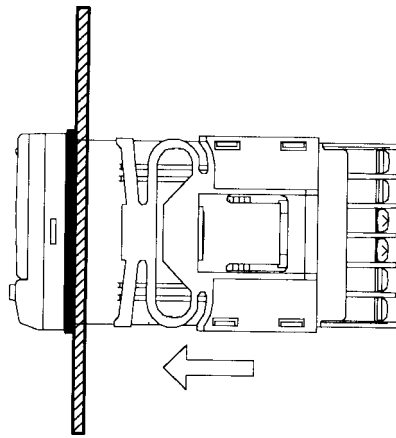

■ Visibility of LCD

K3MA is designed to obtain optimum visibility from the angle shown below.

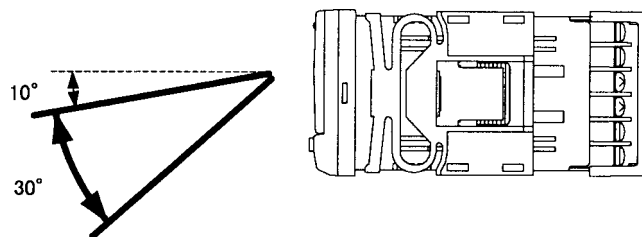

2-2 I/O Terminal Connections

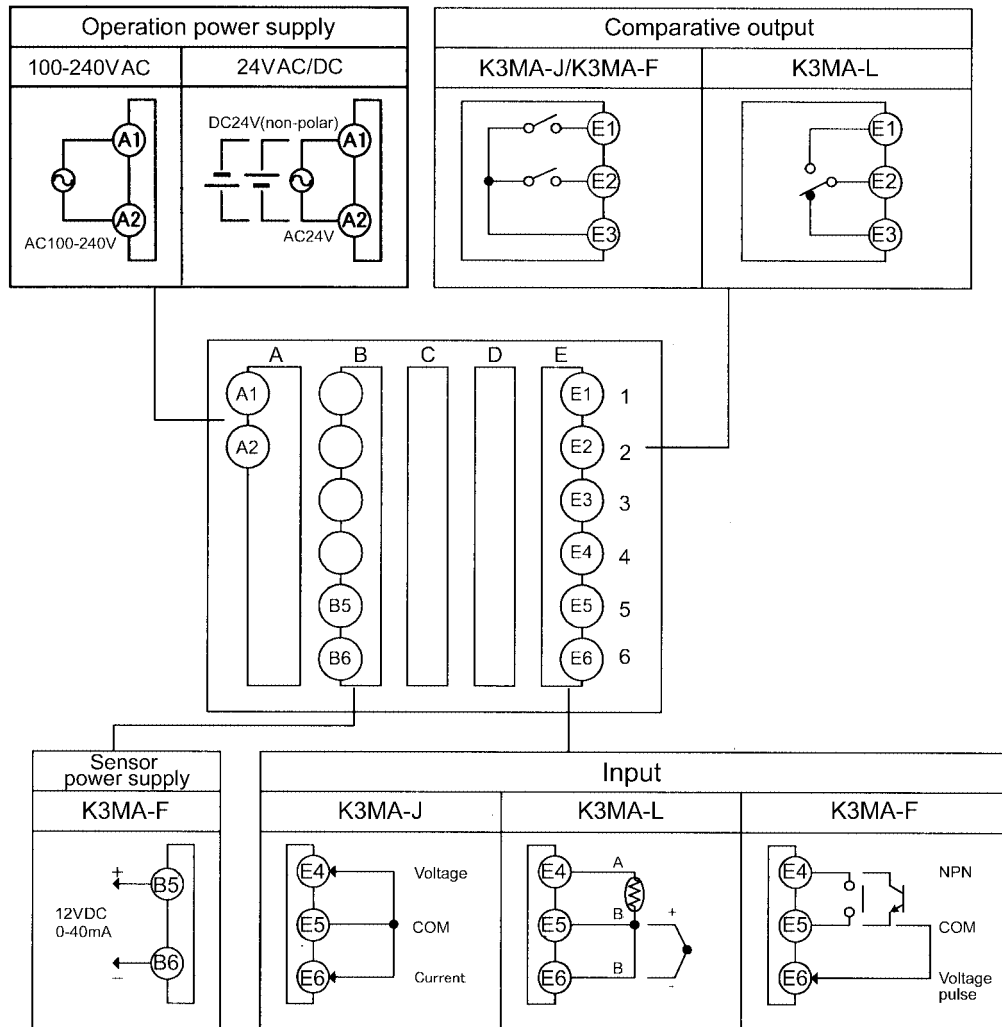

Terminal Arrangement

Terminal No.	Name	Description	Applicable model
A1-A2	Operation power supply	Operation power supply terminals	All models
B5-B6	Sensor power supply	Sensor power supply terminals	K3MA-F
E1-E3 E2-E3	Comparative output	Provides comparative output.	K3MA-J/K3MA-F
E1/E3-E2			K3MA-L
E4/E6-E5	Input	Voltage /current analog terminals	K3MA-J
E4-E5-E6		Thermometer/resistance thermometer terminals	K3MA-L
E4/E6-E5		Open collector pulse/voltage pulse input device terminals	K3MA-F

Terminal Connection

Use crimp contact type terminals as shown below.

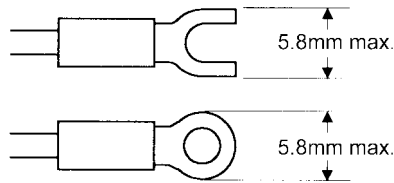

Power Supply

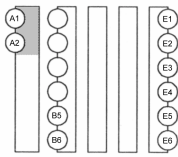

Connect the following power supply to terminals A1 and A2.

100-240 VAC	50/60 Hz	6 VA
24 VAC/DC	50/60 Hz	4.5 VA / 4.5 W (Non-polar)

Note that, when turned on, the product will require the operation power supply to have more supply capacity than rated. If multiple products are used, the power supply must be able to afford to supply power to the products.

Sensor Power Supply (Only K3MA-F)

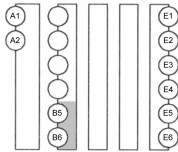

The following sensor power supply can be supplied from terminals B5 and B6.

12VDC	40 mA
-------	-------

Comparative Output

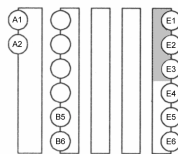

Comparative output is output to terminals E1-E3.

Configuration of contact point is as follows.

K3MA-J/K3MA-F:	1a × 2
K3MA-L:	1c

Connect load within specifications.

The electrical life of the relay is 100,000 times.

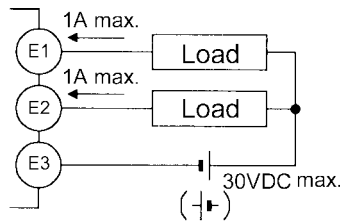

K3MA-J/K3MA-F

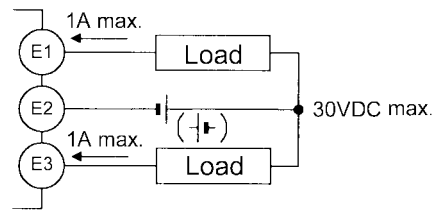

K3MA-L

● Input

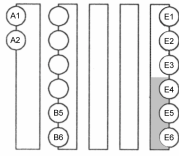

Input signals to be measured.

Input that can be measured by each model is as follows:

Voltage/Current (K3MA-J)

According to the input type, connect input devices to terminals shown below.

Be sure not to exceed the absolute maximum rating even for a moment.

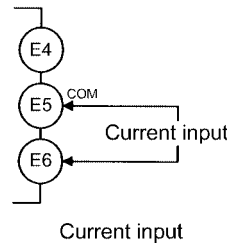
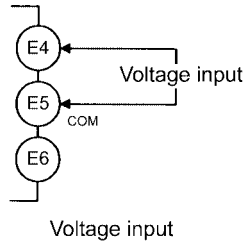

Temperature (K3MA-L)

According to the input type, connect input devices to the terminals E4-E6.

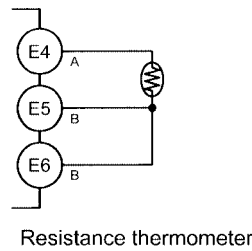
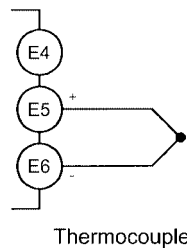

Pulse signals (K3MA-F)

According to the types of signals to be input, connect input devices as shown below.

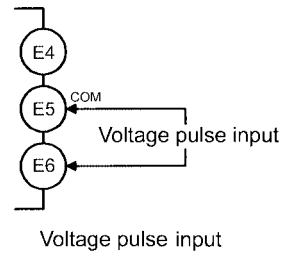
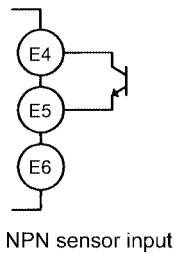
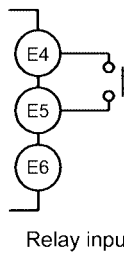

For the PNP sensor input connection, refer to "1-3 I/O Circuit".

The input equipment connected to these terminals must meet the following conditions.

Transistor:	ON residual voltage:	2.5 V max.
	OFF leakage current:	0.1 mA max.
	Current leakage with Transistor turned ON:	15 mA min.
Relay:	Min. load current:	5 mA max.
Voltage pulse:	H Level:	4.5 to 30 V
	L Level:	0 to 2 V
	Input impedance:	10KΩ

CHAPTER 3

APPLICATION EXAMPLES

This chapter shows some examples of product applications.

3-1	Monitoring the Liquid Level (K3MA-J)	3-2
3-2	Monitoring the Internal Pressure of a Tank (K3MA-J)	3-4
3-3	Monitoring the Temperature of an Industrial Furnace (K3MA-L)	3-6
3-4	Monitoring the Feed Speed of a Conveyer (K3MA-F)	3-8
3-5	Monitoring the Rotational Speed by Monitor Output of an Inverter (K3MA-F) ...	3-10

3-1 Monitoring the Liquid Level (K3MA-J)

Application

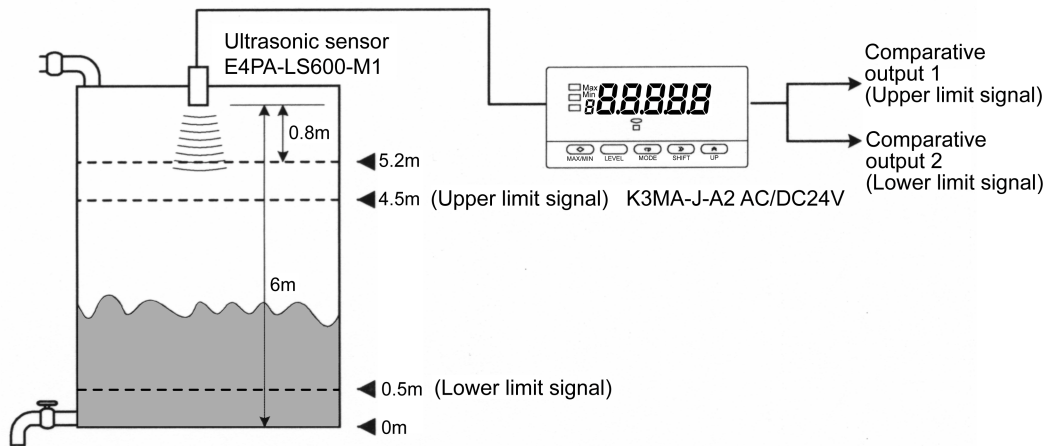

- K3MA-J monitors the liquid level.
- Using an ultrasonic displacement sensor, E4PA-LS600-M1, the distance to the liquid level is detected.
(When the distance is 800-6000 mm, the output of the E4PA-LS600-M1 is 4-20 mA.)
- The unit of indicated values by the K3MA-J is "m", and the values are indicated to three decimal places.
- Four measurements are averaged for stable indication.
- Since the liquid can not be completely discharged, the liquid level less than 0.05 m is always indicated as 0 m.
- When the liquid level reaches 4.5 m, the comparative output 1 is turned ON.
- When the liquid level decreases to 0.5 m, the comparative output 2 is turned ON.

Wiring

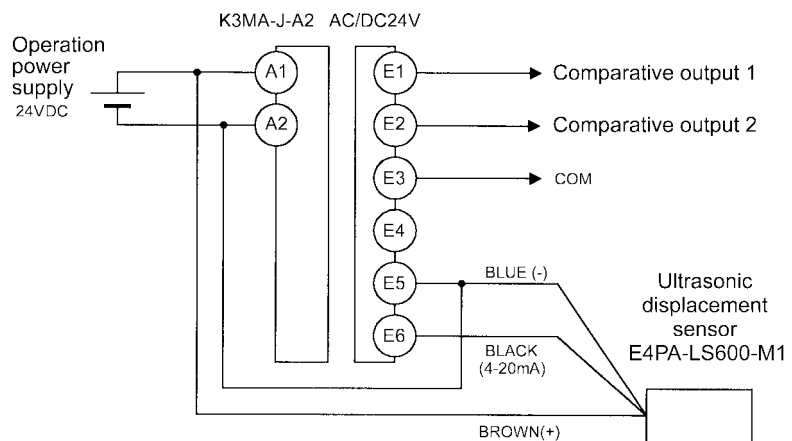

Parameter Setting

- The scaling is set as follows.
 INP1: 4.00
 DSP1: 5200
 INP2: 20.00
 DSP2: 0
 Position of decimal point: 00.000
- The times of measurements for averaging is set to 4.
- The zero-limit is turned ON and the zero-limit value is set to 50.
- Comparative output 1 is used to generate an upper-limit signal action and the OUT upper-limit value is set to "4.500 m".
- Comparative output 2 is used to generate a lower-limit signal action and the OUT lower-limit value is set to "0.500 m".

Level	Parameter	Set value
Initial setting	Unit	4-20
	INP.1	4.00
	dSP.1	5200
	INP.2	20.00
	dSP.2	0
	dP	00.000
	OUT 1t	Ht
	OUT 2t	L0
Advanced-function setting	AUG	4
	Z-Lt	0n
	Lt-P	50
Operation setting	OUT 1	4.500
	OUT 2	0.500

For details of parameters, refer to "CHAPTER 5 OPERATION".

The analog output characteristic mode of the sensor is set to "decrease". For details on sensor setting, refer to the Operation Manual for the sensor E4PA.

Operation

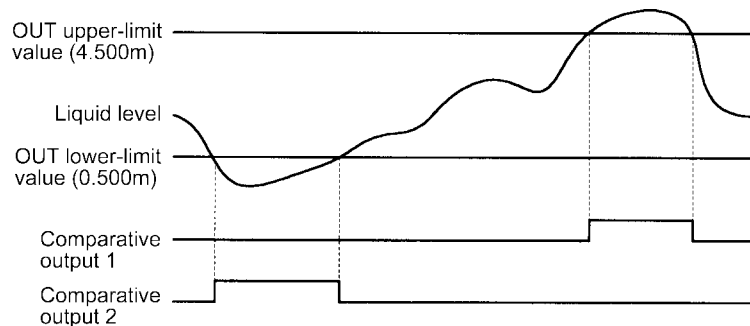

- When the liquid level reaches 4.5 m, comparative output 1 is output.
- When the liquid level decreases to 0.5 m, comparative output 2 is output.

3-2 Monitoring the Internal Pressure of a Tank (K3MA-J)

Application

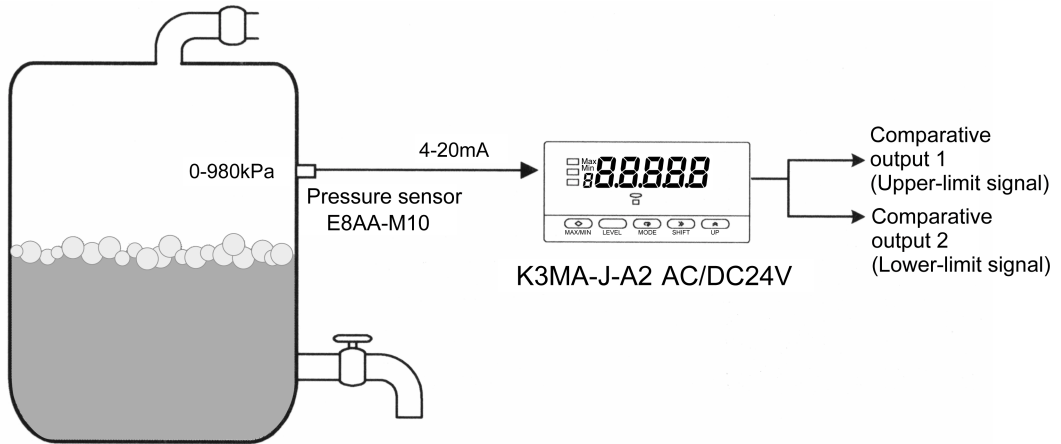

- The K3MA-J monitors the internal pressure of a tank.
- The internal pressure of the tank is measured with a pressure sensor E8AA-M10. (When the pressure is 0-980 kPa, current of 4-20 mA is generated.)
- The unit of indicated values by the K3MA-J is "kPa", and the values are indicated to one tenth's.
- When the internal pressure of the tank reaches 550 kPa, comparative output 1 is turned ON.
- When the internal pressure of the tank decreases to 100 kPa, comparative output 2 is turned ON.

Wiring

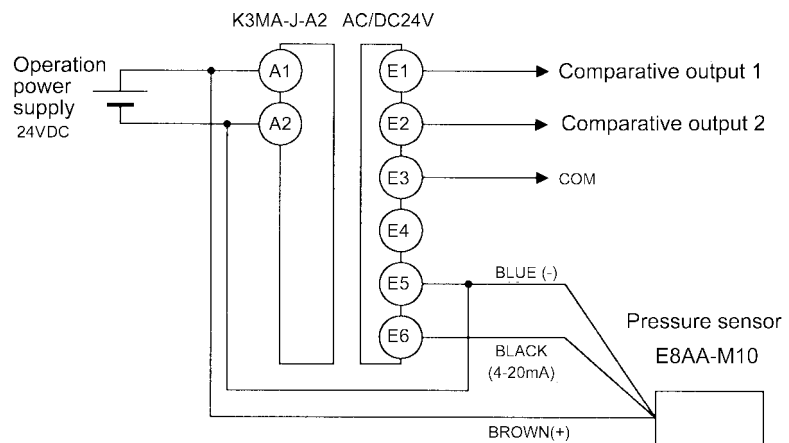

Parameter Setting

- The scaling is set as follows.
 - INP1: 4.00
 - DSP1: 0
 - INP2: 20.00
 - DSP2: 9800
 - Position of decimal point: 00000.0
- Comparative output 1 is used to generate an upper-limit signal action and the OUT upper-limit value is set to "550.0 kPa".
- Comparative output 2 is used to generate a lower-limit signal action and the OUT lower-limit value is set to "100.0 kPa".

Level	Parameter	Set value
Initial setting	Unit	4-20
	INP.1	4.00
	dSP.1	0
	INP.2	20.00
	dSP.2	9800
	dP	00000.0
	OUT 1L	H _L
	OUT 2L	L ₀
Operation setting	OUT 1	550.0
	OUT 2	100.0

For details of parameters, refer to "CHAPTER 5 OPERATION".

Operation

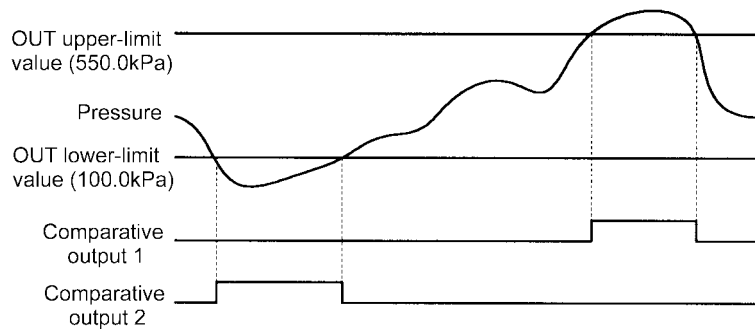

- When the internal pressure of the tank reaches 550.0 kPa, comparative output 1 is turned ON.
- When the internal pressure decreases to 100.0 kPa, comparative output 2 is turned ON.

3-3 Monitoring the Temperature of an Industrial Furnace (K3MA-L)

Application

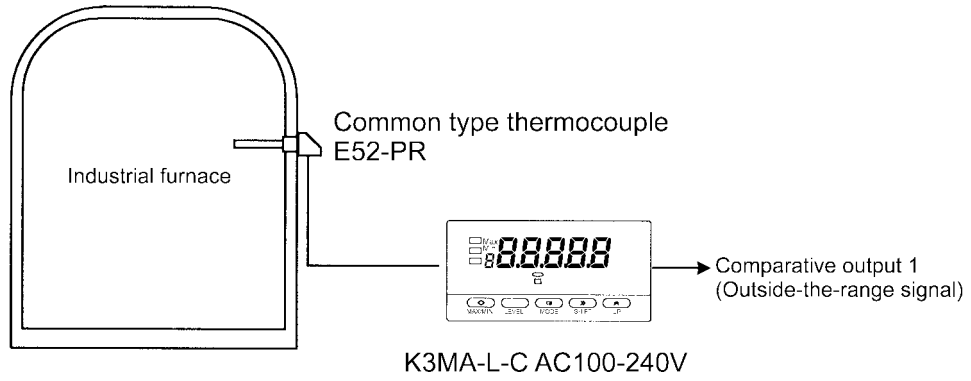

- The K3MA-L monitors the temperature of an industrial furnace.
- The internal temperature of the furnace is measured with a thermocouple E52-PR. (The temperature range to be measured by E52-PR is 0-1,400 °C.)
- The unit of indicated values by the K3MA-L is "°C".
- When the internal temperature of the furnace reaches 1000 °C or lower than 800 °C, comparative output 1 is turned ON.

Wiring

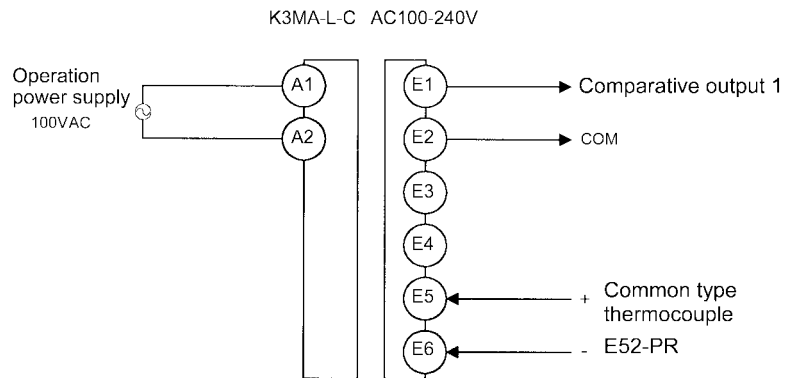

Parameter Setting

- The input type is set to 16 (R element).
- The unit of temperature is set to "°C".
- Comparative output 1 is used as outside-the-range signal action, and the OUT upper-limit value is set to "1000°C" and the OUT lower-limit value is set to "800°C".

Level	Parameter	Set value
Initial setting	Input	16
	Unit	°C
	OUT L.L.	800
Operation setting	OUT U.L.	1000
	OUT L.L.	800

For details of parameters, refer to "CHAPTER 5 OPERATION".

Operation

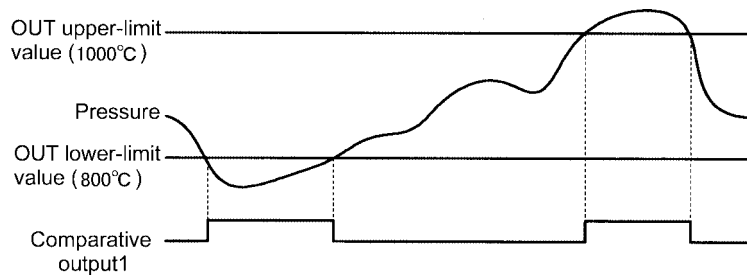

- When the internal temperature reaches 1000 °C or lower than 800 °C, comparative output 1 is turned ON.

3-4 Monitoring the Feed Speed of a Conveyer (K3MA-F)

Application

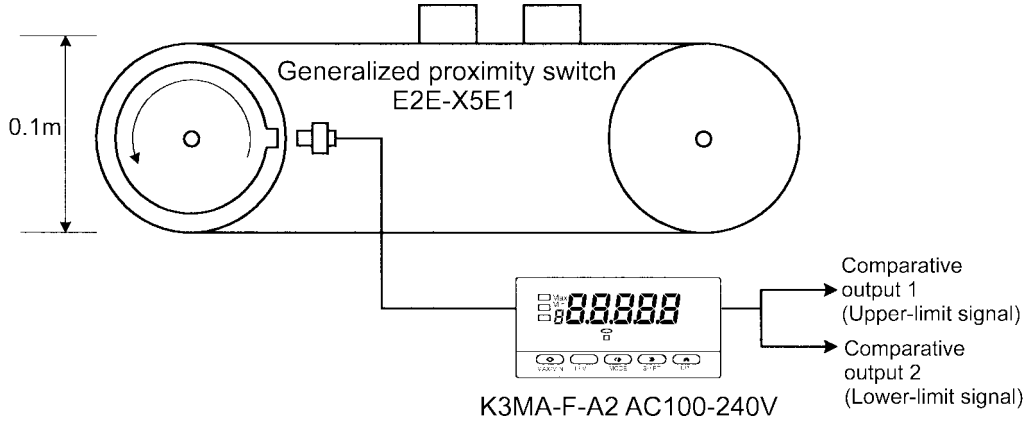

- The K3MA-F monitors the feed speed of a conveyer.
- Two rollers with a diameter of 0.1 m are used for the conveyer.
- A gear to detect the speed of rotation is attached to the axis of one roller and its rotation is converted into pulse signals by a proximity switch E2E-X5E1.
- The unit of indicated values by the K3MA-F is "m/min" and the values are indicated to one tenth's.
- When the speed reaches 22.0 m/min, comparative output 1 is turned ON.
- When the speed decreases to 18.0 m/min, comparative output 2 is turned ON.

Wiring

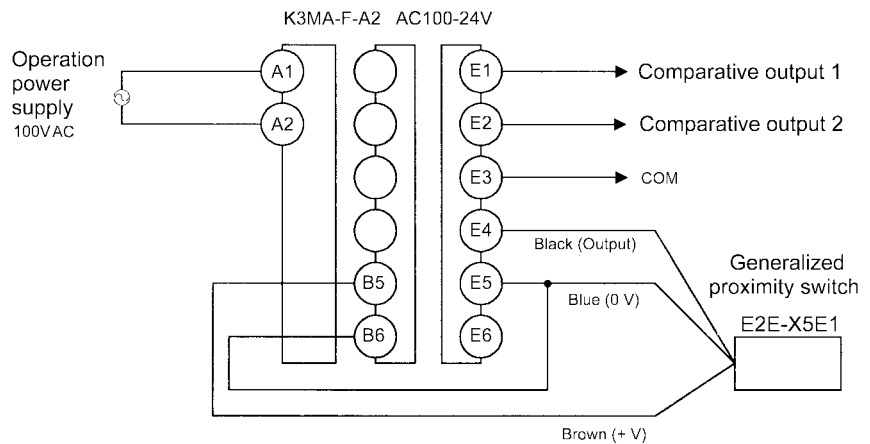

Parameter Setting

- The scaling is set as follows.
 INP: 100
 DSP: 18850
 Position of decimal point: 00000.0

(Calculation of scaling value)

Peripheral velocity D is expressed by the next equation.

$$\text{Peripheral velocity } D \text{ (m/min)} = f \times 60 \times d \times \pi$$

f: Frequency (Hz)

d: Roller diameter (m)

The scaling factor ($60 \times d \times \pi$) is calculated and multiplied by 10 to indicate down to one tenth's. The value obtained is 188.496.

The scaling factor is set to a larger value to minimize the errors.

(INP is set to "100" and DSP is set to "18850.")

- Comparative output 1 is used to generate an upper-limit signal action and the OUT upper-limit value is set to "22.0 m/min."
- Comparative output 2 is used to generate a lower-limit signal action and the OUT lower-limit value is set to "18.0 m/min."

Level	Parameter	Set value
Initial setting	P-FrE	30
	INP	100
	DSP	18850
	dP	00000.0
	OUT1L	H
	OUT2L	L
Operation setting	OUT1	22.0
	OUT2	18.0

For details of parameters, refer to "CHAPTER 5 OPERATION".

Operation

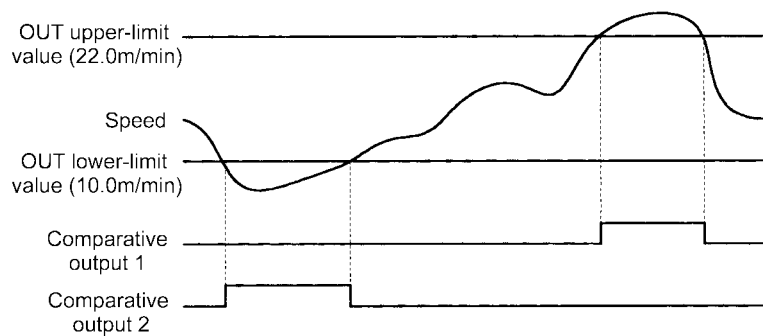

- When the feed speed reaches 22.0 m/min, comparative output 1 is turned ON.
- When the feed speed decreases to 18.0 m/min, comparative output 2 is turned ON.

3-5 Monitoring the Rotational Speed by Monitor Output of an Inverter (K3MA-F)

Application

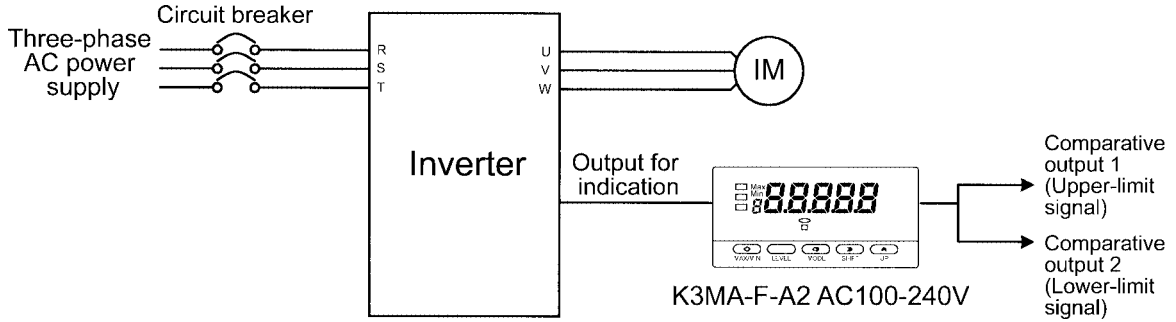

- The K3MA-F monitors the rotational speed by monitor output of an inverter.
- The monitor output of the inverter produces a voltage pulse proportional to the rotational speed of the motor. When the rotational speed of the motor is 60 rps, it produces 1440 Hz.
- The unit of indicated values by the K3MA-F is "rpm".
- When the rotational speed reaches 3000 rpm, comparative output 1 is turned ON.
- When the rotational speed decreases to 2000 rpm, comparative output 2 is turned ON.

Wiring

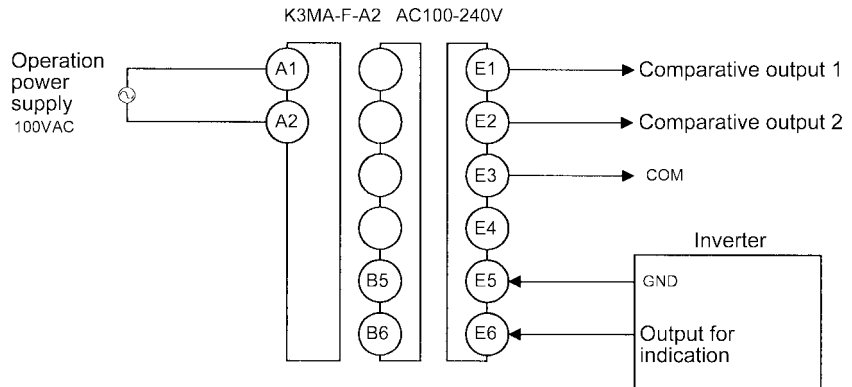

Parameter Setting

- The input type is set to 5K.
- The scaling is set as follows.
 INP: 1440
 DSP: 3600
 Position of decimal point: 000000

(Calculation of scaling factor)

Since 60 rps can be converted into 3600 rpm, the scaling is set in such a way that an input of 1440 Hz is indicated as 3600 rpm.

- Comparative output 1 is used to generate an upper-limit signal action and the OUT upper-limit value is set to "3000 rpm".
- Comparative output 2 is used to generate a lower-limit signal action and the OUT lower-limit value is set to "2000 rpm".

Level	Parameter	Set value
Initial setting	P-FrE	5P
	LnP	1440
	dSP	3600
	dP	000000
	OUT 1t	Hz
	OUT 2t	Lo
Operation setting	OUT 1	3000
	OUT 2	2000

For details of parameters, refer to "CHAPTER 5 OPERATION".

Operation

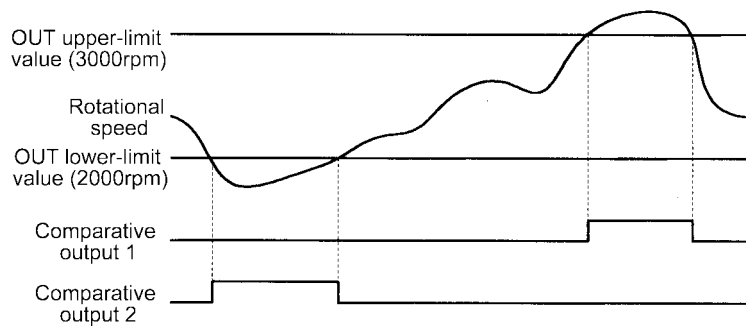

- When the rotational speed reaches 3000 rpm, comparative output 1 is turned ON.
- When the rotational speed decreases to 2000 rpm, comparative output 2 is turned ON.

CHAPTER 4

INITIAL SETTING

The K3MA includes models for Process meter, Temperature meter, and Frequency/Rate meter Device.

This chapter explains the flow of initial setting for each of these models.

4-1	K3MA-J (Process meter)	4-2
4-2	K3MA-L (Temperature meter)	4-4
4-3	K3MA-F (Frequency/Rate meter)	4-6

4-1 K3MA-J (Process meter)

The following example shows the flow of initial setting for K3MA-J.

<Setting example>

Input signals ranging from 0 to 10 V is scaled to readouts ranging from 0 to 500.0 rpm.

When the process value (readout) reaches 450.0 rpm, comparative output 1 is produced.

When the process value (readout) decreases to 50.0 rpm, comparative output 2 is produced.

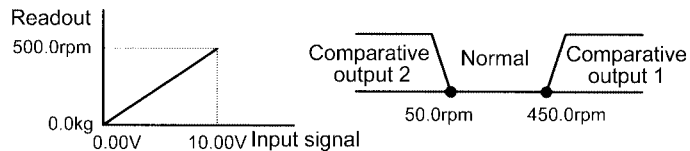

Flow of Initial Setting

A. Check wiring for correct connection and power the product on.

The product is factory set to have an analog input range of 4 to 20 mA.

If an input that falls outside this range is received, the main indicator of the product will read "5.8.8" and blink, indicating an "input range over" error occurs. This is not a trouble of the product.

B. Set "input type" to "±10 V".

1. Make sure the main indicator displays the current process value (the product is at the operation level). Then press the key for at least 3 seconds. The product will move to the initial setting level.
2. Set parameter "I_{IN}" to "10".

C. Specify the scaling factor.

1. Set parameter "I_{SP.1}" to "0.00".
2. Set parameter "dSP.1" to "0".
3. Set parameter "I_{SP.2}" to "10.00".
4. Set parameter "dSP.2" to "5000".

D. Specify the decimal point position.

1. Set parameter "dP" to "0000.0".

E. Set "OUT1 value type" to "upper limit" and "OUT2 value type" to "lower limit".

1. Set parameter "OUT 1.1" to "H_L".
2. Set parameter "OUT 2.1" to "L_H".

NOTE

The "input type", "scaling factor", and "decimal point position" should be set in this order.

Otherwise, auto-initialization of parameters may result in a failure in parameter setting.

If you specify the scaling factor and then the input type, the scaling factor is initialized automatically.

F. Set the OUT1 value to "450.0" and the OUT2 value to "50.0".

1. Make sure the main indicator displays an initial setting level parameter (the product is at the initial setting level). Then press the key and hold it down for at least one second. The product will move to the operation level.
2. Set parameter "OUT 1" to "450.0".
3. Set parameter "OUT 2" to "50.0".

TIPS

The "number of measurements for averaging" and "hysteresis" can be changed if required. These parameters are to be set at the advanced-function setting level.

G. Bring the product into measuring operation.

Clear All

If you are confused about how parameters have been set during initial setting, you can clear all the parameters and start all over again.

For details on how to clear all parameters, refer to Section 5-17 Clearing All Parameters.

*For details on parameter setting, refer to "CHAPTER 5 OPERATION".

4-2 K3MA-L (Temperature meter)

The following example shows the flow of initial setting for K3MA-L.

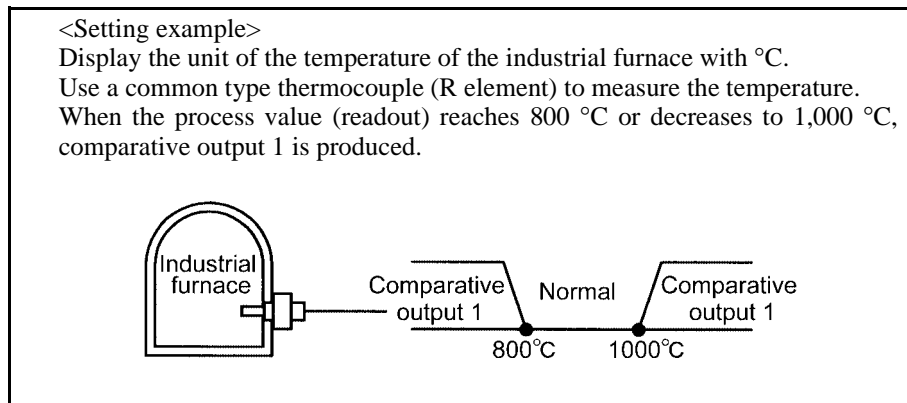

Flow of Initial Setting

- A.** Check wiring for correct connection and power the product on.

The product is factory set to have an input type of "5" (thermocouple K: -200-1300 °C).

- B.** Set "input type" to "thermocouple (R: 0-1700 °C)".

1. Make sure the main indicator displays the current process value (the product is at the operation level). Then press the key for at least 3 seconds. The product will move to the initial setting level.
2. Set parameter "27-1" to "16".

- C.** Set "temperature unit" to "°C".

1. Set parameter "d-U" to "E".

- D.** Set "OUT1 value type" to "outside-the-range".

1. Set parameter "OUT1 L" to "H-L".

- E.** Set the OUT1 upper-limit value to "1000" and the OUT1 lower-limit value to "800".

1. Make sure the main indicator displays an initial setting level parameter (the product is at the initial setting level). Then press the key for at least one second. The product will move to the operation level.
2. Set parameter "OUT1 H" to "1000".
3. Set parameter "OUT1 L" to "800".

TIPS

The "number of measurements for averaging" and "hysteresis" can be changed if required. These parameters are to be set at the advanced-function setting level.

F. Bring the product into measuring operation.

Clear All

If you are confused about how parameters have been set during initial setting, you can clear all the parameters and start all over again.

For details on how to clear all parameters, refer to "5-17 Clearing All Parameters".

*For details on parameter setting, refer to "CHAPTER 5 OPERATION".

4-3 K3MA-F (Frequency/Rate meter)

The following example shows the flow of initial setting for K3MA-F.

<Setting example>
 The speed of a belt conveyer is indicated with the unit of m/min.
 The number of pulses per one rotation of the rotor is 4.
 The diameter of the rotor is 12 cm.
 When the process value reaches 10.500 m/min, comparative output 1 is produced.
 When the process value decreases to 9.500 m/min, comparative output 2 is produced.

How to Determine the Scaling Factor

Determine the scaling factor as follows.

$$\begin{aligned} &\text{Rotor rotational speed (r/min)} \\ &= \text{Input frequency (Hz)} / \text{Number of pulses per rotation} \times 60 \\ &\text{Belt speed (m/min)} = \pi \times \text{Rotor diameter (m)} \times \text{Rotational speed (r/min)} \end{aligned}$$

Hence the speed is given as

$$\text{Belt speed (m/min)} = 3.14159 \dots \times 0.12 \times 60/4 \times \text{Input frequency (Hz)}.$$

Namely,

$$\text{Belt speed (m/min)} = 5.654866 \dots \times \text{Input frequency (Hz)}.$$

Multiply the result by 1000 to enable a readout to be displayed to three decimal places.

$$\text{Belt speed (m/min)} = 5654.866 \dots \times \text{Input frequency (Hz)}.$$

To minimize the scaling operation error, select a convenient numerical value for the scaling input value and such a combination of input value and readout that allows readouts to contain the largest possible number of digits. In this example, the input frequency is set to 10 Hz so that the readout is 56549.

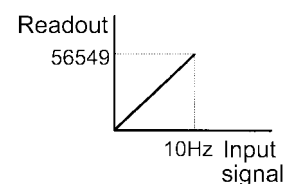

Flow of Initial Setting

A. Check wiring for correct connection and power the product on.

The product is factory set to have a pulse frequency of 5 kHz.

B. Set "pulse frequency" to "30 Hz".

NOTE

"Pulse frequency", "scaling factor", and "decimal point position" should be set in this order.

Otherwise, auto-initialization of parameters may result in a failure in parameter setting. If you specify the scaling factor and then the pulse frequency, the scaling factor is initialized automatically.

1. Make sure the main indicator displays the current process value (the product is at the operation level). Then press the key for at least three seconds. The product will move to the initial setting level.
2. Since it is considered that, taking the application into account, input frequency may be around 2 Hz, may be less than 30 Hz at all events, set the parameter at the initial setting level "P-FrE" to "30".

C. Specify the scaling factor.

1. Set parameter "LrP" to "10.00".
2. Set parameter "dSP" to "56549".

D. Specify the "decimal point position".

1. Set parameter "dP" to "00.000".

E. Set "OUT1 value type" to "upper limit", and "OUT2 value type" to "lower limit".

1. Set parameter "OUT 1t" to "H".
2. Set parameter "OUT 2t" to "L".

F. Set the OUT1 value to "10.500" and the OUT2 value to "9.500".

1. Make sure the main indicator displays an initial setting level parameter. Then press the key for at least one second. The product will move to the operation level.
2. Set parameter "OUT 1" to "10.500".
3. Set parameter "OUT 2" to "9.500".

G. Bring the product into measuring operation.

TIPS

The "number of measurements for averaging" and "hysteresis" can be changed if required. These parameters are to be set at the advanced-function setting level.

Clear All

If you are confused about how parameters have been set during initial setting, you can clear all the parameters and start all over again.

For details on how to clear all parameters, refer to "5-17 Clearing All Parameters".

*For details on parameter setting, refer to "CHAPTER 5 OPERATION".

CHAPTER 5

OPERATION

This chapter describes how to move among levels, change parameters, and operate the product from the front panel.

5-1	Levels	5-2
5-2	Moving among Levels	5-3
5-3	Parameters	5-5
5-4	Set Values	5-6
5-5	Viewing and Changing OUT Set Values	5-7
5-6	Setting/Releasing the Forced-zero Operation (K3MA-J)	5-9
5-7	Displaying/Resetting the MAX/MIN Value	5-10
5-8	Specifying the Temperature Input Correction Value (K3MA-L)	5-11
5-9	Key Protect Setting	5-12
5-10	Selecting an Input Type (K3MA-J/K3MA-L)	5-14
5-11	Selecting an Input-pulse Frequency (K3MA-F)	5-16
5-12	Specifying the Scaling Factor (K3MA-J)	5-17
5-13	Specifying the Scaling Factor (K3MA-F)	5-19
5-14	Specifying the Decimal Point Position (K3MA-J/K3MA-F)	5-22
5-15	Specifying the Temperature Unit (K3MA-L)	5-23
5-16	Selecting a Comparative Output	5-24
5-17	Clearing All Parameters	5-25
5-18	Specifying the Number of Measurements for Averaging	5-26
5-19	Specifying the Hysteresis	5-27
5-20	Specifying the Auto-zero Time (K3MA-F)	5-28
5-21	Specifying the Start-up Compensation Time (K3MA-F)	5-30
5-22	Specifying the Zero-limit (K3MA-J)	5-31
5-23	Changing the Display Color	5-33
5-24	Changing the Display Auto-return Time	5-34
5-25	Changing the Move-to-Protect-Level Time	5-35

5-1 Levels

The setting items of the product are grouped into five "levels" as follows.

Level	Function	Measurement
Protect	This level allows parameter setting for protection against unauthorized or inadvertent key operation. Access to protected levels or setting items is disabled.	Yes
Operation	This level represents the normal operation state in which the product can accept input signals and provide comparative outputs. At this operation level, not only readout of the current process value but also access to or changes of OUT set values are allowed. The product enters this level at power-on.	Yes
Adjustment	This level executes specifying the temperature input correction value. (Only K3MA-L.)	Yes
Initial setting	This level allows initial setting of the input type, type of OUT set values, and scaling factor.	No
Advanced-function setting	This level allows setting of the number of measurements for averaging. Customizations such as a change in display color are also possible at this level.	No

During operation of the product, the level indicator designates the current level. Alphabetic characters shown on the level indicator and their corresponding levels are shown below.

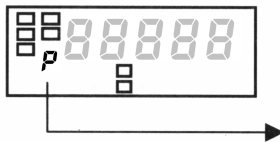

Character	Level
P	Protect level (Protect)
OFF	Operation level
A	Adjustment level (Adjustment)
S	Initial Setting level (initial Setting)
F	Advanced Function setting level (advanced Function setting)

5-2 Moving among Levels

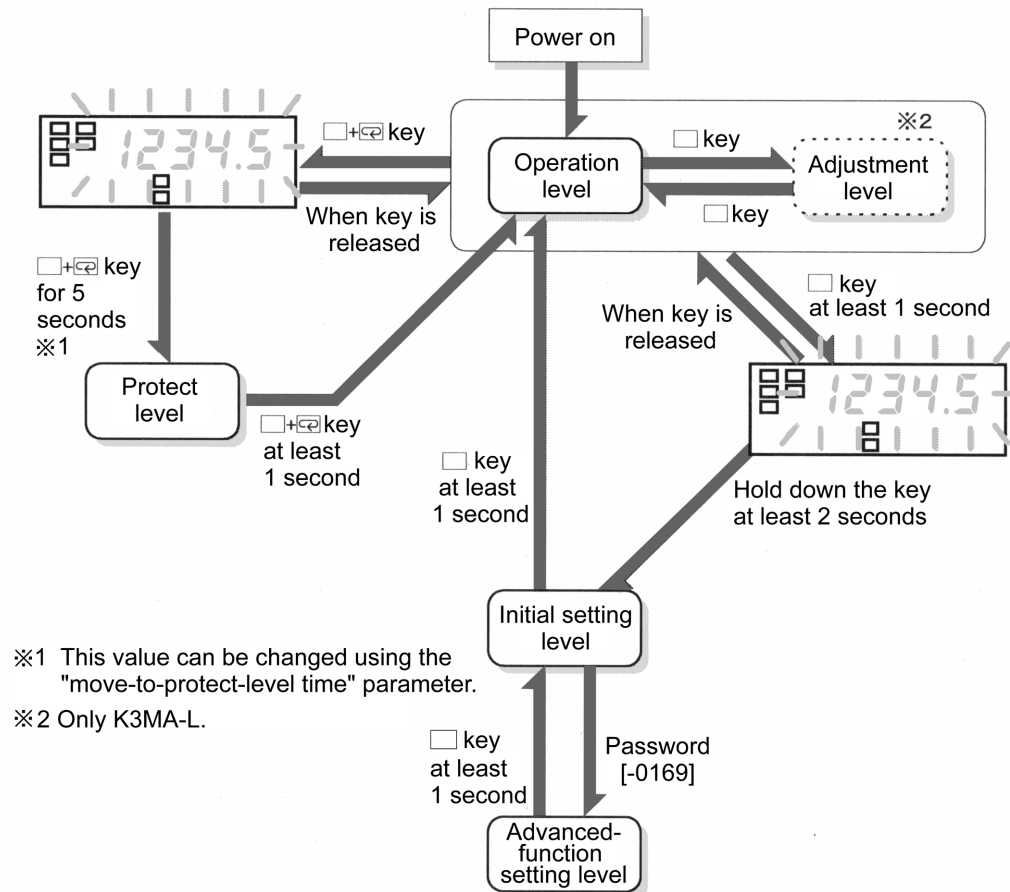

Moving to the protect level

Press the + keys simultaneously and hold them down for at least 5 seconds. The main indicator starts blinking and then the product enters the protect level. The time required for moving to the protect level can be changed using the "move-to-protect-level time" parameter at the advanced-function setting level.

To return from the protect level to the operation level, press the + keys simultaneously and hold them down for at least one second.

Moving to the adjustment level

Press the key at the operation level. When you release the key, the product enters the adjustment level.

To return from the adjustment level to the operation level, press the key.

Moving to the initial setting level

Press the key and hold it down for one second. The main indicator starts blinking. Continue holding the key down further at least two seconds. The product will return to the initial setting level.

To return from the initial setting level to the operation level, press the key and hold it down for at least one second.

Moving to the initial setting level

Moving to the advanced-function setting level involves some particular steps. Proceed as follows.



Procedure

A. Move to the initial setting level and press the  key to display the "advanced-function setting level" parameter.

- Parameter "Añõu" will appear on the main indicator.

B. Press the  key to cause the set value of the parameter (password) to appear on the main indicator.

C. Press the  key again to allow the password to be changed.

D. Use the  and  keys to enter a password of "-0169".

E. Press the  key to save the password.

- If the password is correct, the product enters the advanced-function setting level.
- If the password is incorrect, the product remains at the initial setting level and its indicator displays the next initial setting parameter.

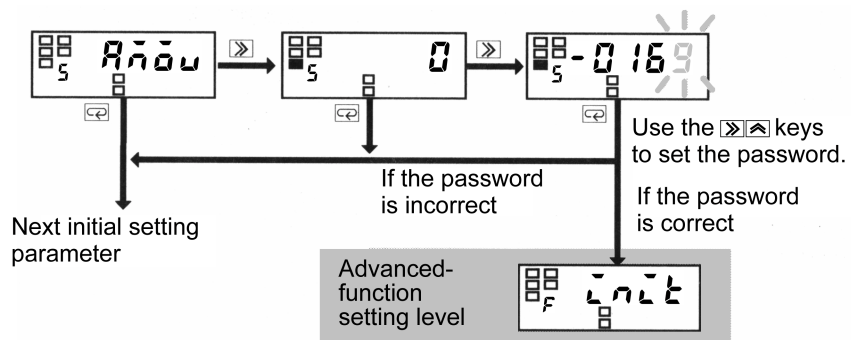

5-3 Parameters

Setting items at each level are called "parameters".

Use the  key to select a parameter.

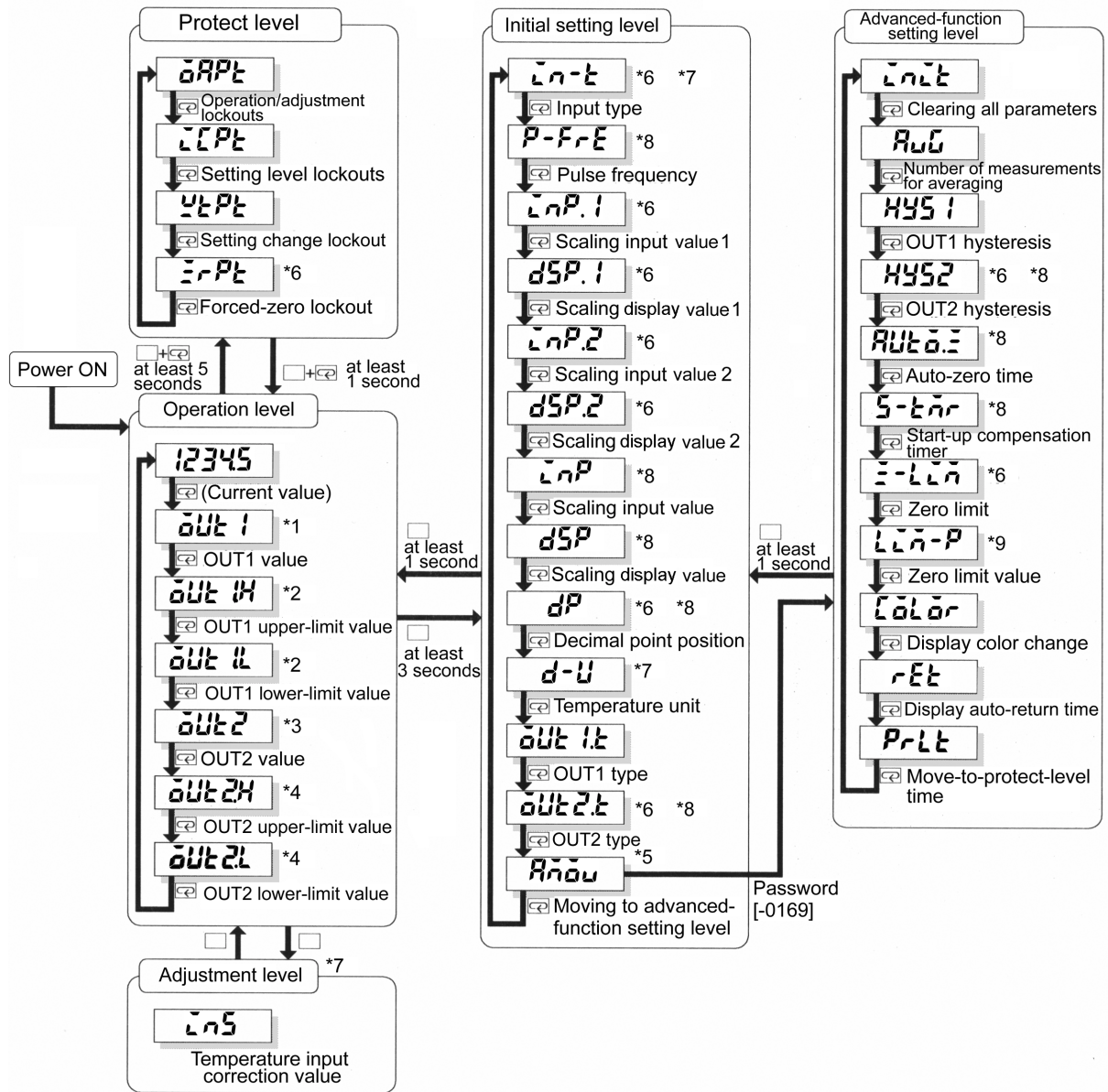

OPERATION

TIPS

Conceptual figure for setting scaling

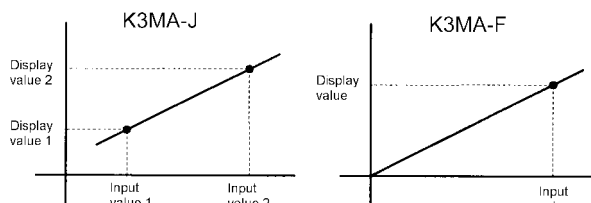

- *1 Is displayed when the parameter "OUT1 type" is "upper-limit" or "lower-limit".
- *2 Is displayed when the parameter "OUT1 type" is "outside-the-range".
- *3 Is displayed when the parameter "OUT2 type" is "upper-limit" or "lower-limit".
- *4 Is displayed when the parameter "OUT2 type" is "outside-the-range".
- *5 Is displayed when the parameter "Setting level lockout" is "0".
- *6 Is displayed with K3MA-J.
- *7 Is displayed with K3MA-L.
- *8 Is displayed with K3MA-F.
- *9 Is displayed when the parameter "zero limit" is "ON".

5-4 Set Values

Parameter settings are called "**set values**".

Set values include those consisting of "numerics" and "alphabets".

A state in which a set value is being displayed on the main indicator is called "**the monitor state**". A state in which a set value can be changed is called "**the change state**".

Perform the following steps to display or change a set value.

Procedure

A. Press the  key when a parameter is displayed on the main indicator. The product enters the monitor state and the set value of the parameter will be displayed on the main indicator.

- When the product is in the monitor state, "SV" in the operation indicator section is illuminated, indicating the readout on the main indicator is a set value.

B. If you do not want to change the set value, press the  key in the monitor state to go to the next parameter.

C. Press the  key in the monitor state to cause the product to enter the change state.

- A digit that can be changed will start blinking.

D. Use the  and  keys to change the set value.

- If no key is operated for five seconds, the product saves the current value and returns to the monitor state automatically.

E. Press the  key to go to the next parameter.

- The change in setting is saved in memory

TIPS

During setting of operation or adjustment level parameters, the return action of the product varies depending on the "display auto-return time" setting.

If the "display auto-return time" is set to less than five seconds, e.g., three seconds, no key operation for three seconds in the change state will return the product to the current value display mode, not to the monitor state.

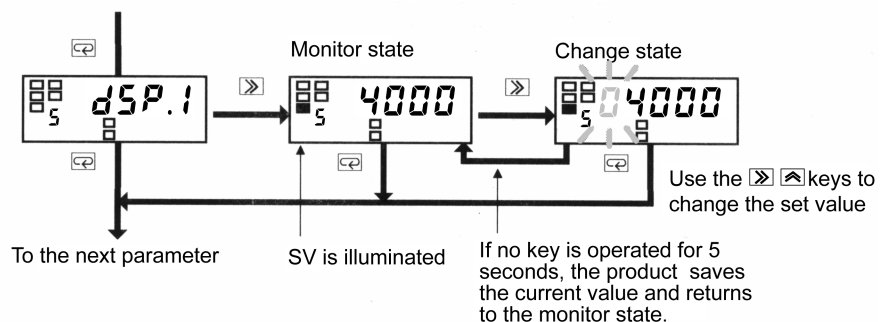

5-5 Viewing and Changing OUT Set Values Operation level

out**

(OUT**)

The operation level allows you to check and change OUT set values.

The product continues measuring in the middle of checking and changing OUT set values.

Procedure

A. Press the  key several times until parameter OUT2 is displayed on the main indicator.

B. Press the  key to display the OUT2 value on the main indicator.

- The product enters the monitor state and shows the OUT2 value on the main indicator.
- "SV" in the operation indicator section is illuminated, indicating the value shown on the main indicator is a set value.
- If you simply want to check the set value, proceed to step **E.**

C. Press the  key in the monitor state to cause the product to enter the change state.

- A digit that can be changed will start blinking.

D. Use the  and  keys to change the set value.

- If no key is operated for five seconds, the product saves the current value and returns to the monitor state automatically.

E. Press the  key several times until the product returns to the current value display mode.

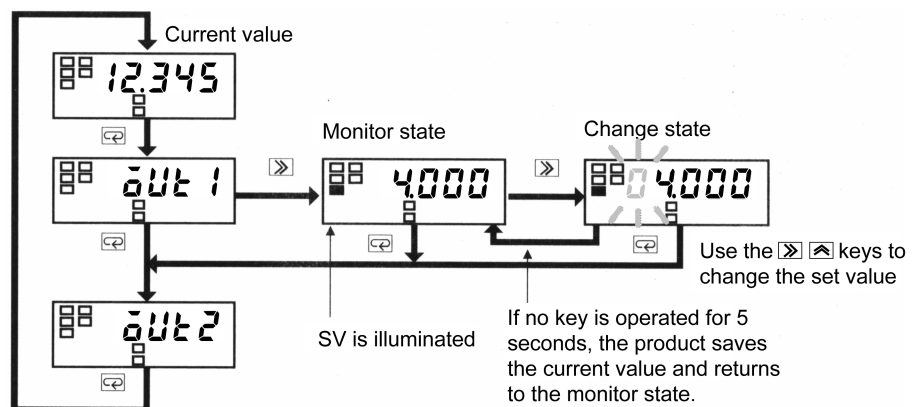

Available OUT set values and their indications are as follows.

OUT set value	Indication	Description
OUT1 value	OUT 1	When the process value increases or decreases to this value, comparative output 1 is provided.
OUT1 upper-limit value	OUT 1H	When the process value falls outside-the-range specified by these values, comparative output 1 is provided.
OUT1 lower-limit value	OUT 1L	
OUT2 value	OUT 2	When the process value increases or decreases to this value, comparative output 2 is provided.
OUT2 upper-limit value	OUT 2H	When the process value falls outside-the-range specified by these values, comparative output 2 is provided.
OUT2 lower-limit value	OUT 2L	

(With K3MA-L, OUT2 value, OUT2 upper-limit value, and OUT2 lower limit value are not available.)

For details of comparative output, refer to "6-5 Comparative Output".

5-6 Setting/Releasing the Forced-zero Operation (K3MA-J)

Operation level

■ Setting the forced-zero

The forced-zero operation allows you to shift the current value to zero forcedly.

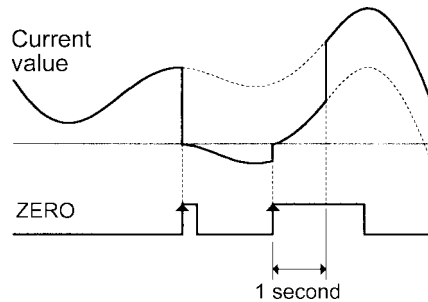

Procedure

A. Press the  key when a current value is displayed on the main indicator. (Release the key within one second.)

- The current value will be shifted to zero.
- "ZERO" in the operator indication section is illuminated, indicating the current value has been shifted to zero.

TIPS

The forced-zero operation is not available when the current value is not normal (input abnormally, outside-the-range specified, not measured yet).

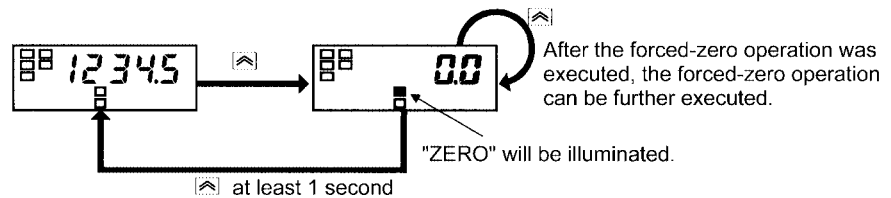

■ Releasing the forced zero

Release the forced-zero operation.

Procedure

A. Press the  key and hold it down for at least one second when a shifted value is displayed.

- The shifted value will be restored to the current value.
- "ZERO" in the operation indicator section will go off, indicating the current value is no longer shifted.

5-7 Displaying/Resetting the MAX/MIN Value

Operation level

■ Displaying the MAX/MIN value

The maximum value (MAX) and minimum value (MIN) of the current value can be displayed.

Procedure

A. Press the  key when a current value is displayed on the main indicator.

- The MAX value will be displayed on the main indicator.
- "Max" in the operator indicator section is illuminated, indicating the value shown on the main indicator is the MAX value.

B. Press the  key when the MAX value is displayed on the main indicator.

- The MIN value will be displayed on the main indicator.
- "Min" in the operation indicator section is illuminated, indicating the value shown on the main indicator is the MIN value.

C. Press the  key when the MIN value is displayed on the main indicator.

- A current value will be displayed on the main indicator.
- "Max" or "Min" in the operation indicator section will go off, indicating the value shown on the main indicator is a current value.

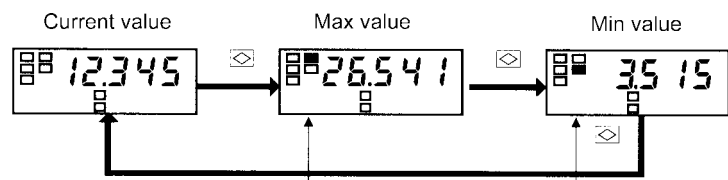

"Max" will be illuminated "Min" will be illuminated

Press the "" key and hold it down for one second when the Max or Min value is displayed. The Max/Min value will be reset to a current value.

■ Resetting the MAX/MIN Value

The MAX value and MIN value can be reset to a current value.

Procedure

A. Press the  key for at least one second when a process value (Current value/Max value/Min value) is displayed on the main indicator.

- Both the MAX value and MIN value are reset to a current value.

5-8 Specifying the Temperature Input Correction Value (K3MA-L)

Adjustment level

Ln5
(INS)

This parameter allows you to set a correction value for temperature input.

The input temperature is corrected by the quantity of set value in the whole of sensor range.

If the correction value is 1.2°C, the current value of 200°C before correction will be processed as 201.2°C after correction.

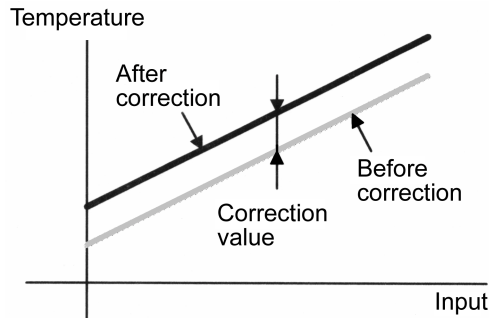

Parameter	Set value	Description
Ln5	-9999-9999	-1999-9999: Temperature input correction value

Procedure

TIPS

No key operation for 10 seconds at the adjustment level causes the product to return to the current value display mode at the operation level automatically.

A. Press the key at the operation level to move to the adjustment level.

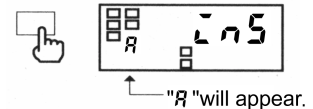

- "R" will appear on the level indicator, indicating the product has entered the adjustment level.

B. Press the key to display the set value of the parameter on the main indicator.

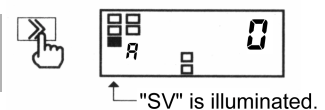

- The current set value for temperature input correction value will appear on the main indicator.

C. Press the key again.

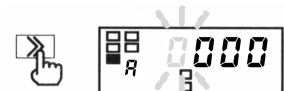

- The set value will start blinking, indicating the product is in the change state.

D. Use the and keys to change the set value.



E. Press the key to save the change.

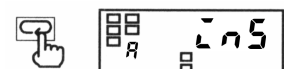

- The change is saved and then the main indicator returns to the parameter display mode.

F. Press the key to return to the operation level.

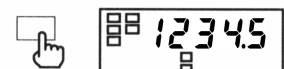

5-9 Key Protect Setting

Protect level

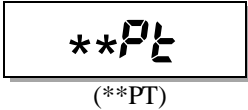

Key protect includes "operation/adjustment lockouts", "setting level lockout", "setting change lockout", and "forced-zero lockout", and allows restrictions on moving among levels and various setting changes.

Operation/ Adjustment Lockouts

This types of key protect restrict the key operation at the operation and adjustment levels.

Parameter	Set value	Operation level		Move to adjustment level
		Current value display	OUT set value display	
δRPt (OAPT)	0	Enable	Enable	Enable
	1	Enable	Enable	Disable
	2	Enable	Disable	Disable

Setting Level Lockout

This type of key protect restricts moving to "initial setting level" and "advanced-function setting level".

Parameter	Set value	Move to initial setting level	Move to advanced-function setting level
ζCPt (ICPT)	0	Enable	Enable
	1	Enable	Disable
	2	Disable	Disable

Setting Change Lockout

This type of key protect restricts the key operation for setting change.

It prohibits the product from entering the changing state, except that the following operation is allowed.

- Changes in set values of all parameters at the protect level
- Move to the advanced-function level

Parameter	Set value	Key operation for setting changes
ψtPt (WTPT)	OFF	Enable
	On	Disable

Forced-zero Lockout

(Only K3MA-J)

This type of key operation restricts the key operation that activates or deactivates the forced-zero function.

Parameter	Set value	Key operation for activating or deactivating the forced-zero function
ΞRPt (ZRPT)	OFF	Enable
	On	Disable

For the factory set values, refer to the "Parameter List" at the end of this document.

Procedure

TIPS

Appropriate setting of the "move-to-protect-level time" parameter allows you to change the time required for the product to move to the protect level.

The move-to-protect-level time is factory set to 5 seconds.

- A.** When the product is at the operation level, press the + keys and hold them down for at least five seconds to enter the protect level.
- + "P" will appear.
- "P" will appear on the level indicator, indicating the product has entered the protect level.
- B.** Press the key several times until the desired parameter appears on the main indicator
- ...
- C.** Press the key to display the set value of the parameter on the main indicator.
- "SV" will be illuminated.
- The current set value will appear on the main indicator
- D.** Press the key again.
-
- The current set value will start blinking, indicating the product is in the change state.
- E.** Use the key to change the set value.
-
- F.** Press the key to go to the next parameter.
-
- The change is saved.
- G.** Press the + keys and hold down them for at least one second to return to the operation level.
- +

5-10 Selecting an Input Type (K3MA-J/K3MA-L) initial setting level

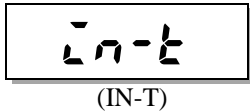

This parameter allows you to select an input type of the product from the following for each product model.

K3MA-J

Parameter	Set value	Description
IN-T (IN-T)	0-20	0-20 mA
	4-20	4-20 mA
	0-5	0-5 V
	1-5	1-5 V
	5	±5 V
	10	±10 V

K3MA-L

Parameter	Set value	Description			
IN-T (IN-T)	0	Resistance thermometer	Pt100	-200-850°C	-300-1500°F
	1			-199.9-500.0°C	-199.9-900.0°F
	2		0.0-100.0°C	0.0-210.0°F	
	3		JPt100	-199.9-500.0°C	-199.9-900.0°F
	4	0.0-100.0°C		0.0-210.0°F	
	5	Thermocouple	K	-200-1300°C	-300-2300°F
	6			-20.0-500.0°C	0.0-900.0°F
	7	J	-100-850°C	-100-1500°F	
	8		-20.0-400.0°C	0.0-750.0°F	
	9	T	-200-400°C	-300-700°F	
	10		-199.9-400.0°C	-199.9-700.0°F	
	11	E	0-600°C	0-1100°F	
	12	L	-100-850°C	-100-1500°F	
	13	U	-200-400°C	-300-700°F	
	14		-199.9-400.0°C	-199.9-700.0°F	
	15	N	-200-1300°C	-300-2300°F	
	16	R	0-1700°C	0-3000°F	
	17	S	0-1700°C	0-3000°F	
18	B	100-1800°C	300-3200°F		

Procedure

TIPS

A change in input type initializes some parameters.

■ K3MA-J

Parameters "LSP.1", "dSP.1", "LSP.2", "dSP.2", and "dP" are initialized according to the selected input type. The forced-zero function is deactivated.

■ K3MA-L

No parameter is initialized.

A. When the product is at the operation level, press the  key and hold it down for at least three seconds to enter the initial setting level.

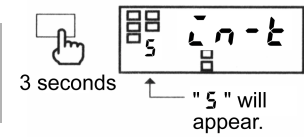

- "5" will appear on the level indicator, indicating the product has entered the initial setting level.
- The first parameter at the initial setting level is "LSP-1".

B. Press the  key to display the set value of the parameter on the main indicator.

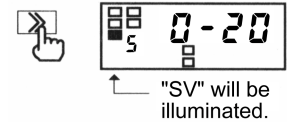

- The set value of the input type will appear on the main indicator.

C. Press the  key again.

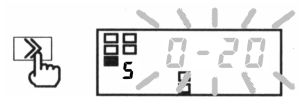

- The current set value starts blinking, indicating the product is in the change state.

D. Use the  key to change the set value.



E. Press the  key to go to the next parameter.

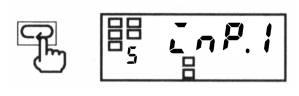

- The change is saved.

F. Specify the values of other parameters related to the input type. (Refer to the "TIPS".)

G. Press the  key and hold it down for at least one second to return to the operation level.

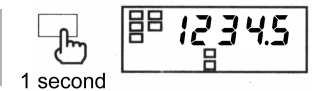

5-11 Selecting an Input-pulse Frequency Initial setting level (K3MA-F)



This parameter allows you to select an input-pulse frequency range. The value of the parameter represents the upper limit of available ranges.

Parameter	Set value	Description
P-FrE	30	Measuring range: 0.05-30 Hz
(P-FRE)	5K	Measuring range: 0.05-5 kHz

If input signals come from relay contacts, set the range to "30 Hz". Doing so eliminates chattering noise from input signals.

Procedure

TIPS

A change in input-pulse frequency range initializes some parameters.

- Parameters "LrP", "dSP", and "dP" are initialized according to the current input-pulse frequency range.

A. When the product is at the operation level, press the key and hold it down for at least three seconds to cause the product to enter the initial setting level.

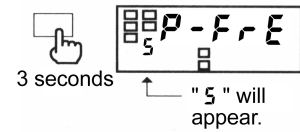

- "5" will appear in the level indicator section, indicating the product has entered the initial setting level.
- The first parameter at the initial setting level is "P-FrE".

B. Press the key to display the set value of the parameter on the main indicator.

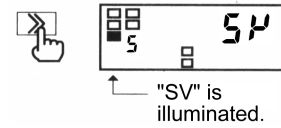

- The current set value of the input-pulse frequency range will appear on the main indicator.

C. Press the key again.



- The set value starts blinking, indicating the product is in the change state.

D. Use the key to change the set value.



E. Press the key to go to the next parameter.

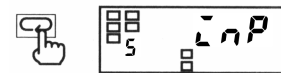

- The change is saved.

F. Specify the values of other parameters related to the input-pulse frequency range. (Refer to the "TIPS".)

G. Press the key and hold it down for at least one second to return to the operation level.



5-12 Specifying the Scaling Factor (K3MA-J) initial setting level

INP.*

(INP.*)

DSP.*

(DSP.*)

These parameters allow you to specify the scaling factor when you want to cause the product to display a desired value converted from the input value.

Parameter	Set value	Description
INP.1	19999-99999	Input value corresponding to DSP.1.
DSP.1	19999-99999	Output value corresponding to INP.1.
INP.2	19999-99999	Input value corresponding to DSP.2.
DSP.2	19999-99999	Output value corresponding to INP.2.

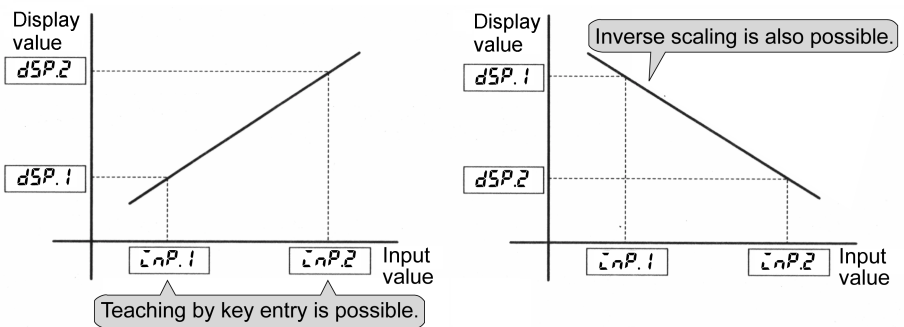

Inverse scaling where readout decreases with increasing input is also possible.

To allow a readout of 0.0 when the input value is 4.2 mA and a readout of 100.0 when the input value is 20 mA, for example, set the parameters as follows.

- INP.1 = 4.20
- DSP.1 = 0
- INP.2 = 20.00
- DSP.2 = 1000

TIPS

The decimal point position of parameters "INP.1" and "INP.2" is automatically illuminated.

- 4-20 mA: 000.00
- 1-5 V: 00.000
- ±5 V: 00.000
- ±10 V: 000.00

Specify the decimal point position of the display value with parameter "DSP".

Procedure

A. When the product is at the operation level, press the key and hold it down for at least three seconds to enter the initial setting level.

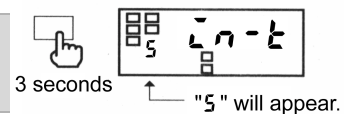

- "5" will appear on the level indicator, indicating the product has entered the initial setting level.

B. Press the key several times until the parameter "INP.1" appears on the main indicator.

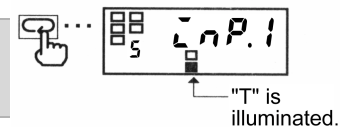

- "T" will be illuminated, indicating teaching of this parameter (scaling input value 1) is possible.
- For the procedure of teaching, refer to the next page.

C. Press the key to display the set value of the parameter on the main indicator.

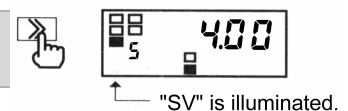

- The current set value of scaling input value 1 will appear on the main indicator.

D. Press the key again.

- The current set value starts blinking, indicating the product is in the change state.

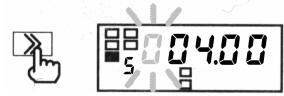

E. Use the and keys to change the set value.



F. Press the key to go to the next parameter "dSP.1".

- The change in setting is saved and "dSP.1" will appear on the main indicator.

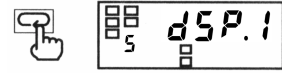

G. Repeat the operations of **C.** to **F.** to set the parameters "dSP.1", "LrP.2", and "dSP.2".

- When the parameter "dSP.2" has been set, the next parameter "dP" will appear on the main indicator.

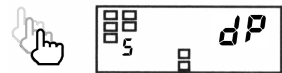

H. Press the key and hold it down for at least one second to return to the operation level.



Teaching scaling

The teaching function allows you to specify the value of parameters "LrP.1" and "LrP.2" also by key entry.

Procedure

I. The operation of **C.** causes the product to enter the monitor state. In the monitor state, press the key instead of the operation of **D.**.

- "T" will start blinking, indicating the product is in teaching mode.
- Key entry permits the actual process value to be displayed on the main indicator.

J. Press the key again.

- The actual process value is set as the input value and then the product will return to the monitor state.
- Pressing the key instead of the key in teaching mode cancels the teaching mode and the display on the main indicator changes to the next parameter.

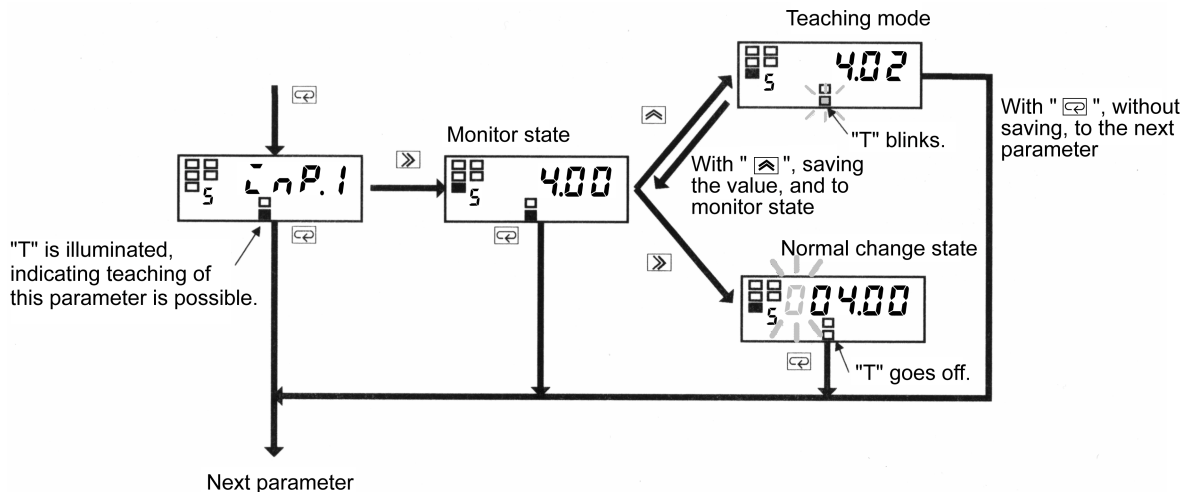

5-13 Specifying the Scaling Factor (K3MA-F) Initial setting level



(INP)

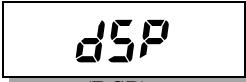

(DSP)

These parameters allow you to specify the scaling factor when you want to cause the product to display a desired value converted from the input value

Parameter	Set value	Description
INP	0-99999	Input value corresponding to dSP.
dSP	19999-99999	Readout corresponding to INP.

For the calculation of scaling, refer to "6-3 Measurement (K3MA-F)".

TIPS

The decimal point position of parameter "INP" is automatically illuminated depending on the set value of input-pulse frequency range as follows.

- 30 Hz: 0000.00
- 5 kHz: 00000

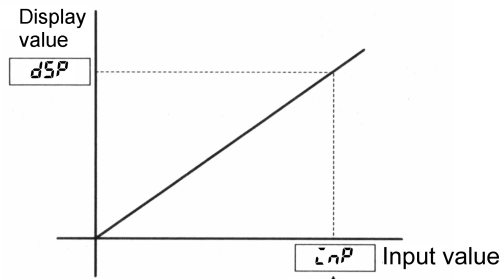

To allow a readout of 10.000 when the input value is 4.2 kHz (= 4200 Hz), for example, set the parameters as follows.

- INP = 4200
- dSP = 10000

Specify the decimal point position of the display value with parameter "dP".

TIPS

To convert a frequency into a revolution speed or a peripheral velocity, use the following equation.

$$\text{Revolution speed} = f \times 60 \div P \quad (\text{rpm})$$

$$\text{Peripheral velocity} = f \times 60 \div P \times R \times \pi \quad (\text{m/min})$$

- f: Frequency(Hz)
- P: Number of pulses per rotation
- R: Diameter of rotor (m)

Procedure

A. When the product is at the operation level, press the key and hold it down for at least three seconds to enter the initial setting level.

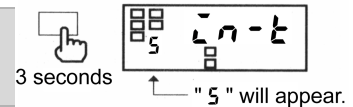

- "5" will appear on the level indicator, indicating the product has entered the initial setting level.

B. Press the key several times until the parameter "INP" appears on the main indicator.

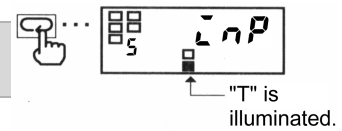

- "T" will be illuminated, indicating teaching of this parameter (scaling input value) is possible.
- For the procedure of teaching, refer to the next page.

C. Press the key to display the set value of the parameter on the main indicator.



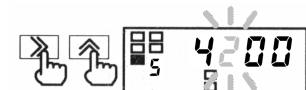

- The current set value of scaling input value will appear on the main indicator.

D. Press the key again.



- The current set value starts blinking, indicating the product is in the change state.

E. Use the  and  key to change the set value.

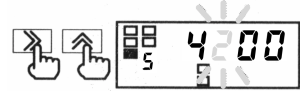

F. Press the  key to go to the next parameter.

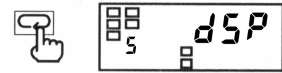

- The change in setting is saved and "dSP" will appear on the main indicator.

G. Repeat the operations of **C.** to **F.** to set the parameter "dSP"

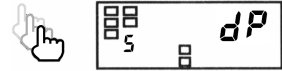

- When the parameter "dSP" has been set, the next parameter "dP" will appear on the main indicator.

H. Press the  key and hold it down for at least one second to return to the operation level.



Teaching scaling



The teaching function allows you to specify the value of parameter "L nP" also by key entry.

Procedure

I. The operation of **C.** causes the product to enter the monitor state. In the monitor state, press the  key instead of the operation of **D.**.

- "T" will start blinking, indicating the product is in teaching mode.
- Key entry permits the actual process value to be displayed on the main indicator.

J. Press the  key again.

- The actual process value is set as the input value and then the product will return to the monitor state.
- Pressing the  key instead of the  key in teaching mode cancels the teaching mode and the display on the main indicator changes to the next parameter.

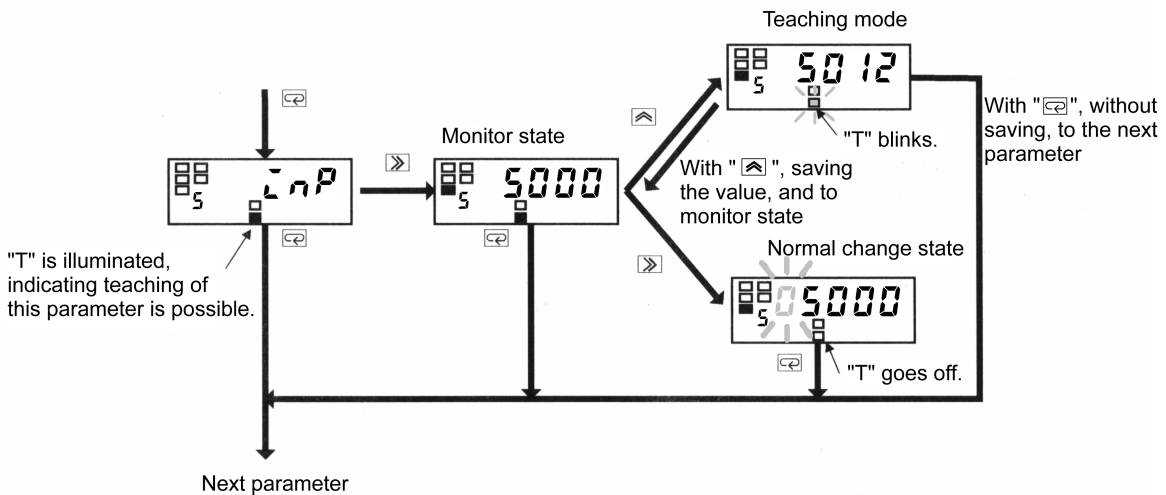

How to Determine Appropriate Scaling Factor

To minimize the scaling operation error, select such a scaling factor that permits the largest possible number of digits to be contained in scaling display values (DSP).

The relationship between the scaling input and display values for input pulse frequency is represented by the following equation.

$$\text{Scaling display value} = \alpha (\text{multiplication factor}) \times \text{Input frequency (Hz)}$$

Where $\alpha = \text{DSP} \div \text{INP}$.

α is often an indivisible number such as $\alpha = 5.654866\dots$ particularly when the input value is converted to a circumferential velocity. This is because such a conversion involves π .

There are innumerable combination of scaling input values (INP) and scaling display value (DSP) that result in $\alpha = 5.654866\dots$ as follows.

INP (Hz)	DSP
1	5.654866...
2	11.30973...
5	28.27433...
10	56.54866...
...	

On the other hand, DSPs that are programmable are limited to 5-digit integers. This means that DSPs must be rounded off to the nearest integers as follows.

INP (Hz)	Programmable DSP
1	00006
2	00011
5	00028
10	00057
...	

Hence, if the input frequency is 1000 Hz, the error between the scaling result and the ideal value increases with the decreasing number of digits contained in the DSP.

INP (Hz)	Programmable DSP	Scaling result (Readout)	Ideal value	Error
1	00006	6000	5655	345
2	00011	5500	5655	155
5	00028	5600	5655	55
10	00057	5700	5655	45
..				

Select a combination of the DSP and INP so that the scaling output contains the largest possible number of digits. Doing so minimizes the scaling operation error.

5-14 Specifying the Decimal Point Position (K3MA-J/K3MA-F)

Initial setting level



This parameter allows you to specify the decimal point position of the display value.

Parameter	Set value	Description
dP (DP)	0.0000	Readouts are given to four decimal places.
	00.0000	Readouts are given to three decimal places.
	000.00	Readouts are given to two decimal places.
	0000.0	Readouts are given to one decimal place.
	00000	Readouts are given as integers.

Procedure

A. When the product is at the operation level, press the key and hold it down for at least three seconds to enter the initial setting level.

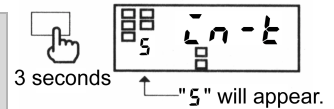

- "5" will appear on the level indicator, indicating the product has entered the initial setting level.

B. Press the key several times until parameter "dP" appears on the main indicator.

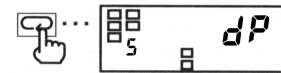

C. Press the key to display the set value of the parameter.

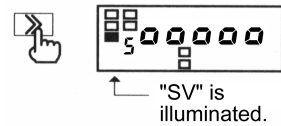

- The current set value for the decimal point position will appear on the main indicator.

D. Press the key again.



- The set value starts blinking, indicating the product is in the change state.

E. Use the key to change the set value.



F. Press the key to go to the next parameter.

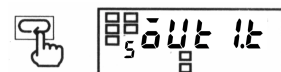

- The change is saved.

G. Press the key and hold it down for at least one second to return to the operation level.

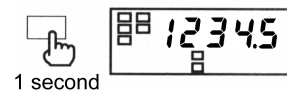

5-15 Specifying the Temperature Unit

(K3MA-L)

Initial setting level

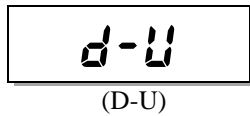

This parameter allows you specify the temperature unit.

Parameter	Set value	Description
d-U	C	°C
(D-U)	F	°F

Procedure

A. When the product is at the operation level, press the  key and hold it down for at least three seconds to enter the initial setting level.

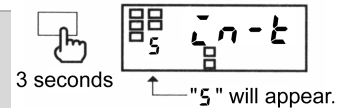

- "5" will appear on the level indicator, indicating the product has entered the initial setting level.

B. Press the  key several times until parameter "d-U" appears on the main indicator.

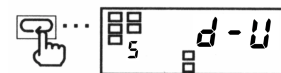

C. Press the  key to display the set value of the parameter on the main indicator.

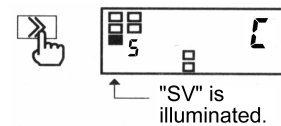

- The current set value for the temperature unit will appear on the main indicator.

D. Press the  key again.



- The set value starts blinking, indicating the product is in the change state.

E. Use the  key to change the set value.



F. Press the  key to go to the next parameter.



- The change is saved.

G. Press the  key and hold it down for at least one second to return to the operation level.

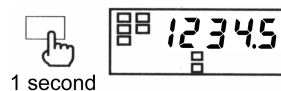

5-16 Selecting a Comparative Output

Initial setting level

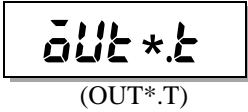

These parameters allow you to select the comparative output 1 or output 2.

Parameter	Set value	Description
OUT 1.T or OUT 2.T	H \bar{L}	Upper limit: Upper-limit action
	L \bar{O}	Lower limit: Lower-limit action
	H \bar{L} -L \bar{O}	Outside-the-range: outside-the-range action

For the details of comparative output operating action, refer to "6-5 Comparative Output".

Procedure

TIPS

The parameter of OUT set value to be displayed at the operation level changes according to the set values of these parameters.

- To specify the OUT set value for the upper or lower-limit action, use parameter "OUT*.H".
- To specify the OUT set values for the outside-the-range action, use parameters OUT upper-limit value "OUT*.H" and OUT lower-limit value "OUT*.L".

*: 1 or 2

K3MA-L does not allow you to set the parameter "OUT 2.L".

A. When the product is at the operation level, press the key and hold it down for at least three seconds to enter the initial setting level.

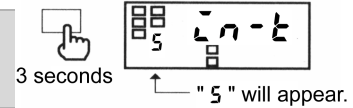

- "5" will appear on the level indicator, indicating the product has entered the initial setting level.

B. Press the key several times until parameter "OUT 1.T" appears on the main indicator.

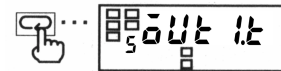

C. Press the key to display the set value of the parameter on the main indicator.

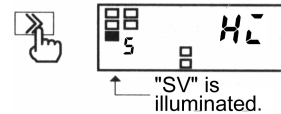

- The current set value for the type of comparative output will appear on the main indicator.

D. Press the key again.

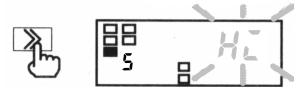

- The set value starts blinking, indicating the product is in the change state.

E. Use the key to change the set value.



F. Press the key to display parameter "OUT 2.T" on the main indicator.

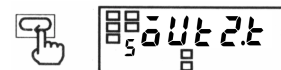

- The change is saved and then the next parameter "OUT 2.T" will appear on the main indicator.

G. Repeat the steps **C.** to **F.** to set parameter "OUT 2.T".

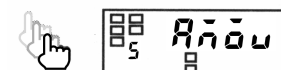

- Parameter "H \bar{L} O" will appear on the main indicator when you finish setting of parameter "OUT 2.T".

H. Press the key and hold it down for at least one second to the operation level.



5-17 Clearing All Parameters

Advanced-function setting level

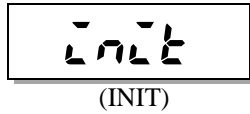

The clear all function can be used to initialize all parameters to factory settings.

Parameter	Set value	Description
INIT	OFF	---
(INIT)	ON	Parameters are all initialized.

TIPS
This parameter is displayed when "Setting level lockouts" is "0".

This function is useful in restarting the setup of the product from the default state.

For the factory set values, refer to the "Parameter List" at the end of this document.

Procedure

A. When the product is at the operation level, press the key and hold down it for at least three seconds to enter the initial setting level.

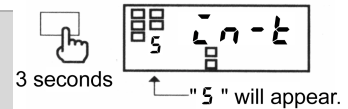

- "5" will appear on the level indicator, indicating the product has entered the initial setting level.

B. Enter password "-0169" in the parameter "A000" to enter the advanced-function setting level. For details on how to move to the advanced-function setting level, refer to "5-2 Moving among Levels".

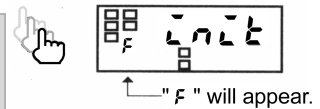

- "F" will appear on the level indicator, indicating the product has entered the advanced-function setting level.
- The first parameter at the advanced-function setting level is "INIT".

C. Press the key to display the set value of the parameter on the main indicator.

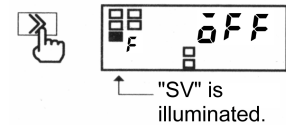

- Set value "OFF" will appear on the main indicator.

D. Press the key again.



- The set value will start blinking, indicating the product is in the change state.

E. Use the key to change the set value to "ON".



F. Press the key to go to the next parameter.



- All parameters are initialized.
- Parameter "INIT" is also set to "OFF".

G. Press the key and hold it down for at least one second to return to the initial setting level.

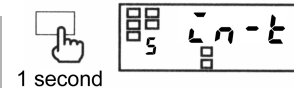

H. Press the key and hold it down for at least one second to return to the operation level.

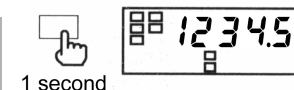

5-18 Specifying the Number of Measurements for Averaging

Advanced-function setting level



(AVG)

This parameter allows you to specify the number of measurements for averaging.

Parameter	Set value	Description
AVG	OFF	No average processing
	2/4/8	Number of measurements for averaging

Procedure

A. When the product is at the operation level, press the key and hold it down for at least three seconds to enter the initial setting level.

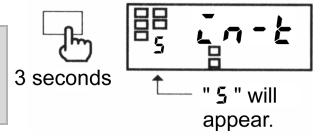

- "5" will appear on the level indicator, indicating the product has entered the initial setting level.

B. Enter password "-0169" in the parameter "P0169" to enter the advanced-function setting level. For details on how to move to the advanced-function setting level, refer to "5-2 Moving among Levels".

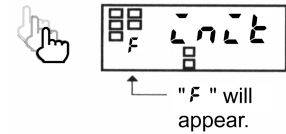

- "F" will appear on the level indicator, indicating the product has entered the advanced-function setting level.

C. Press the key several times until parameter "AVG" appears on the main indicator.

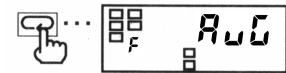

D. Press the key to display the set value.



- The current set value for the number of measurements for averaging will appear on the main indicator.

E. Press the key again.

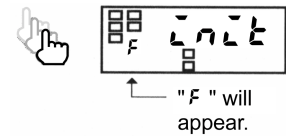

- The set value will start blinking, indicating the product is in the change state.

F. Press the key to change the set value.

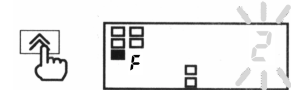

G. Press the key to go to the next parameter.

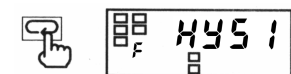

- The change is saved.

H. Press the key and hold it down for at least one second to return to the initial setting level.

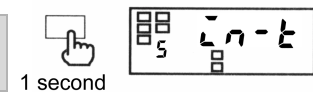

I. Press the key and hold it down for at least one second to return to the operation level.

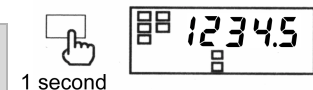

5-19 Specifying the Hysteresis

Advanced-function setting level

HYS*

(HYS*)

TIPS

A hysteresis setting of "0" is assumed to be a hysteresis setting of "1".

With K3MA-L, setting of "5552" is not possible.

These parameters allow you to specify the hysteresis for each of comparative output 1 and 2.

Parameter	Set value	Description
HYS*	0-9999	0 to 9999 digit: Hysteresis

Procedure

A. When the product is at the operation level, press the  key and hold it down for at least three seconds to the initial setting level.

- "5" will appear on the level indicator, indicating the product has entered the initial setting level.

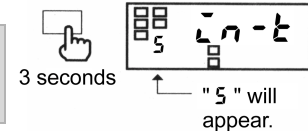

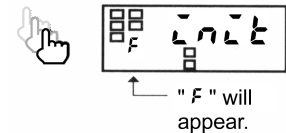

B. Enter password "-0169" in the parameter "PnLw" to enter the advanced-function setting level. For details on how to move to advanced-function setting level, refer to "5-2 Moving among Levels".

- "F" will appear on the level indicator, indicating the product has entered the advanced-function setting level.



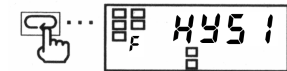

C. Press the  key several times until parameter "HYS 1" appears on the main indicator.

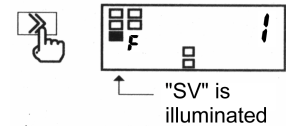

D. Press the  key to display the set value on the main indicator.

- The current set value of event input will appear on the main indicator.



E. Press the  key again.

- The set value will start blinking, indicating the product is in the change state.



F. Use the  and  keys to change the set value.



G. Press the  key to go to parameter "HYS2".

- The change is saved.

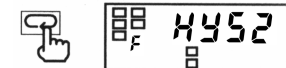

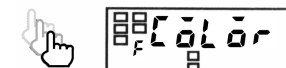

H. Repeat the Steps **D.** to **G.** for parameter "HYS2".

- The next parameter will appear on the main indicator when you finish setting of the parameter.

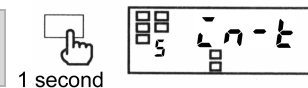

I. Press the  key and hold it down for at least one second to return to the initial setting level.



J. Press the  key and hold it down for at least one second to return to the operation level.

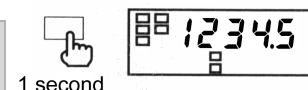

5-20 Specifying the Auto-zero Time (K3MA-F)

Advanced-function setting level



This parameter allows you to specify the auto-zero time.

Parameter	Set value	Description
AUTO.Z	0.0-19.9	0.0 to 19.9 sec: Auto-zero time

The auto-zero time is the length of time required for the product to return the readout to zero after pulse input interruption.

Set this parameter to a larger value than the expected time interval of input pulses (interval between pulses). Failure to do so will result in incorrect measurements.

If auto-zero time is too long, on the other hand, a long delay in lower-limit action in response to a stop of rotation may result.

In the following application where a pulse is produced per rotation at 12-6000 r/min, for example, the input pulse frequency is 0.2 to 100 Hz, which means the time interval of input pulses is 0.01 to 5 seconds. The auto-zero time should be set to five seconds or longer.

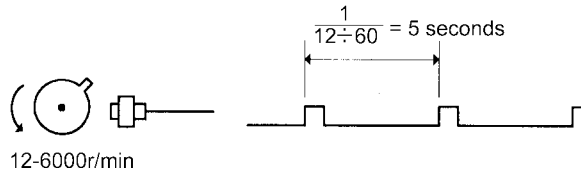

Procedure

A. When the product is at the operation level, press the key and hold it down for at least three seconds to enter the initial setting level.

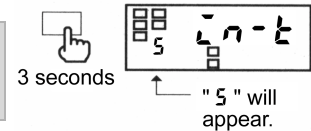

- "5" will appear on the level indicator, indicating the product has entered the initial setting level.

B. Enter password "-0169" in parameter "A000" to enter the advanced-function setting level. For details on how to move to the advanced-function setting level, refer to "5-2 Moving among Levels".

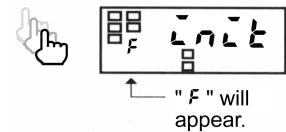

- "F" will appear on the level indicator, indicating the product has entered the advanced-function setting level.

C. Press the key several times until parameter "AUTO.Z" appears on the main indicator.



D. Press the key to display the set value of the parameter on the main indicator.

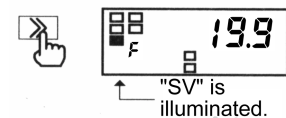

- The current set value of auto-zero time will appear on the main indicator.

E. Press the key again.

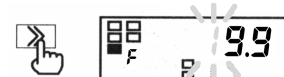

- The set value will start blinking, indicating the product is in the change state.

F. Use the  and  keys to change the set value.

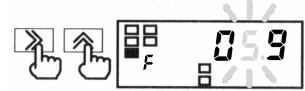

G. Press the  key to go to the next parameter.

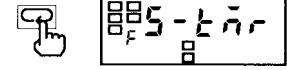

- The change is saved and the next parameter will appear on the main indicator.

H. Press the  key and hold it down for at least one second to return to the initial setting level.



I. Press the  key and hold it down for at least one second to return to the operation level.



5-21 Specifying the Start-up Compensation Time (K3MA-F)

Advanced-function setting level

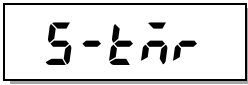

(S-TMR)

This parameter allows you to specify the start-up compensation time.

Parameter	Set value	Description
S-tā	0.0-99.9	0.0 to 99.9 seconds: start-up compensation time

The start-up compensation time is a delay between power-on of the product and the start of measurement. This function is useful in preventing output from being produced until a rotator reaches a prescribed speed.

Procedure

A. When the product is at the operation level, press the key and hold it down for at least three seconds to enter the initial setting level.

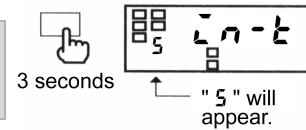

- "S" will appear on the level indicator, indicating the product has entered the initial setting level.

B. Enter password "-0169" in parameter "Añōu" to enter the advanced-function setting level. For details on how to move to the advanced-function setting level, refer to "5-2 Moving among Levels".

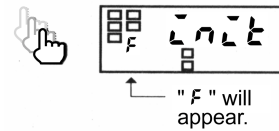

- "F" will appear on the level indicator, indicating the product has entered the advanced-function setting level.

C. Press the key several times until parameter "S-tā" appears on the main indicator.



D. Press the key to display the set value of the parameter on the main indicator.

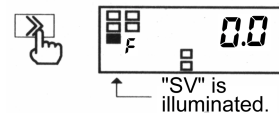

- The current set value of the start-up compensation timer will appear on the main indicator.

E. Press the key again.



- The set value will start blinking, indicating the product is in the change state.

F. Use the and keys to change the set value.



G. Press the key to go to the next parameter.

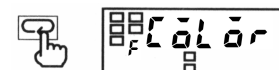

- The change is saved.

H. Press the key and hold it down for at least one second to return to the initial setting level.

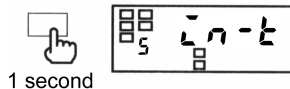

I. Press the key and hold it down for at least one second to return to the operation level.

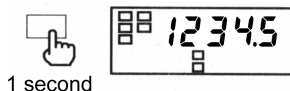

5-22 Specifying the Zero-limit (K3MA-J) Advanced-function setting level

≡-L₀↗
(Z-LIM)

L₀↗-P
(LIM-P)

These parameters allow you to specify the zero-limit.

Parameter	Set value	Description
≡-L ₀ ↗ (Z-LIM)	0FF	OFF: Zero-limit function is not available.
	0n	ON: Zero-limit function
L ₀ ↗-P	0-99	0 to 99: Zero-limit value

The zero-limit is a function to process all the readouts lower than the set value as zero.

When you select "ON", the values lower than the zero-limit value are always displayed as "0".

This function is useful when you want to indicate a minus numerical value as zero or indicate the minimum value of input range as zero.

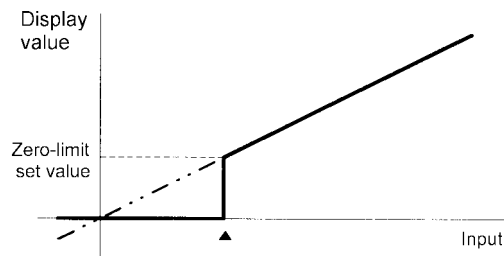

Procedure

- A.** When the product is at the operation level, press the key and hold it down for at least three seconds to enter the initial setting level.

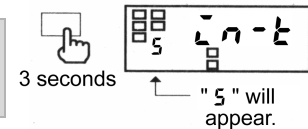

- "5" will appear on the level indicator, indicating the product has entered the initial setting level.

- B.** Enter password "-0169" in parameter "P0169" to enter the advanced-function setting level. For details on how to move to the advanced-function setting level, refer to "5-2 Moving among Levels".

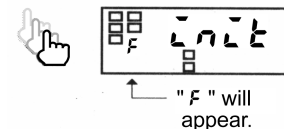

- "F" will appear on the main indicator, indicating the product has entered the advanced-function setting level.

- C.** Press the key several times until parameter "≡-L₀↗" appears on the main indicator.



- D.** Press the key to display the set value of the parameter on the main indicator.

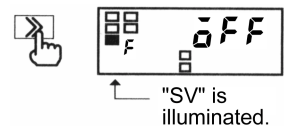

- The current set value of zero-limit will appear on the main indicator.

- E.** Press the key again.

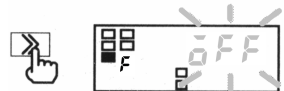

- The set value will start blinking, indicating the product is in the change state.

F. Use the  key to change the set value.

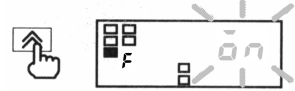

G. Press the  key to go to the next parameter.

- The change is saved and the next parameter "L₂ - P" will appear on the main indicator. (When "OFF" is selected, "L₂ - P" will not appear.)

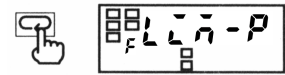

H. Press the  key to display the set value of the parameter on the main indicator.

- The current set value of zero-limit will appear on the main indicator.

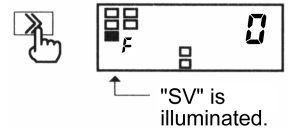

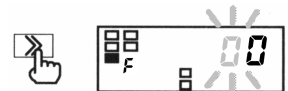

I. Press the  key again.

- The set value will start blinking, indicating the product is in the change state.

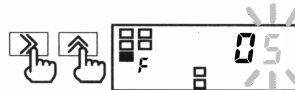

J. Use the  and  keys to change the set value.





K. Press the  key to go to the next parameter.

- The change is saved.

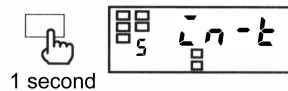

L. Press the  key and hold it down for at least one second to return to the initial setting level.



M. Press the  key and hold it down for at least one second to return to the operation level.



5-23 Changing the Display Color

Advanced-function setting level



This parameter allows you to change the display color of the main indicator.

Parameter	Set value	Description
COLOR (COLOR)	Grn-r	Green-red: The display color is normally green, and changes to red at comparative output ON.
	Grn	Green: The display color is always green.
	Red-G	Red-green: The display color is normally red, and changes to green at comparative output ON.
	Red	Red: The display color is always red.

Procedure

- A.** When the product is at the operation level, press the key and hold it down for at least three seconds to enter the initial setting level.

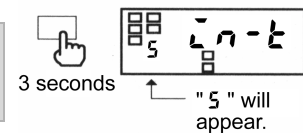

- "5" will appear on the main indicator, indicating the product has entered the initial setting level.

- B.** Enter password "-0169" in parameter "A00" to enter the advanced-function setting level. For details on how to move to the advanced-function setting level, refer to "5-2 Moving among Levels".

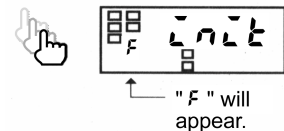

- "F" will appear on the level indicator, indicating the product has entered the advanced-function setting level.

- C.** Press the key several times until parameter "COLOR" appears on the main indicator.



- D.** Press the key to display the set value of the parameter on the main indicator.

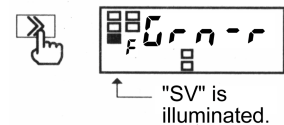

- The current set value of changing the display color will appear on the main indicator.

- E.** Press the key again.



- The set value will start blinking, indicating the product is in the change state.

- F.** Use the key to change the set value.

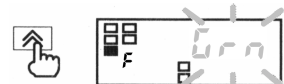

- G.** Press the key to go to the next parameter.

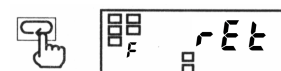

- The change is saved.

- H.** Press the key and hold it down for at least one second to return to the initial setting level.

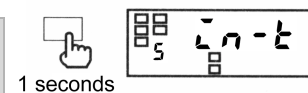

- I.** Press the key and hold it down for at least one second to return to the operation level.

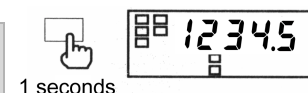

5-24 Changing the Display Auto-return Time

Advanced-function setting level

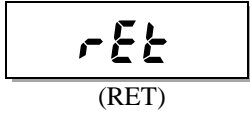

This parameter allows you to change the display auto-return time.

Parameter	Set value	Description
RET (RET)	0	0 sec: Display auto-return is not available.
	1-99	1 to 99 sec: Display auto-return time

TIPS

If the display auto-return function is activated in the middle of parameter setting, the product saves the current value of the parameter and then returns to the current value display mode.

If no key is operated for a prescribed time, the product returns to the current value display mode at the operation/adjustment level. This prescribed time is called the display auto-return time.

Procedure

A. When the product is at the operation level, press the key and hold it down for at least three seconds to enter the initial setting level.

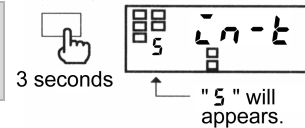

- "5" will appear on the level indicator, indicating the product has entered the initial setting level.

B. Enter password "-0169" in parameter "A000" to enter the advanced-function setting level. For details on how to move to the advanced-function setting level, refer to "5-2 Moving among Levels".

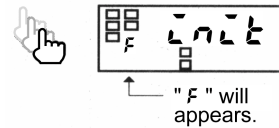

- "F" will appear on the level indicator, indicating the product has entered the advanced-function setting level.

C. Press the key several times until parameter "RET" appears on the main indicator.

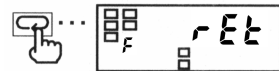

D. Press the key to display the set value of the parameter on the main indicator.

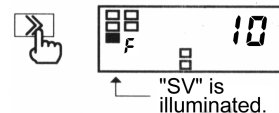

- The current set value of the display auto-return time will appear on the main indicator.

E. Press the key again.

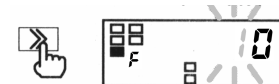

- The set value will start blinking, indicating the product is in the change state.

F. Use the and keys to change the set value.



G. Press the key to go to the next parameter.

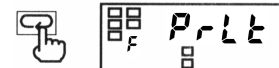

- The change is saved.

H. Press the key and hold it down for at least one second to return to the initial setting level.

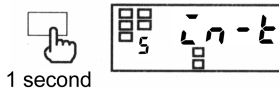

I. Press the key and hold it down for at least one second to return to the operation level.

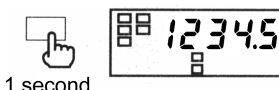

5-25 Changing the Move-to-Protect-Level Time

Advanced-function setting level

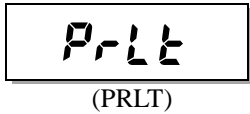

This parameter allows you to change the move-to-protect-level time.

Parameter

Parameter	Set value	Description
P-LLT	0-19	0 to 19 sec: Move-to-protect-level time

If you press the + keys and hold them down for at least five seconds (a prescribed time), the product enters the protect level. This prescribed time is called the move-to-protect-level time.

Depending on the setting of the parameter, the product moves from the operation level to the protect levels as follows.

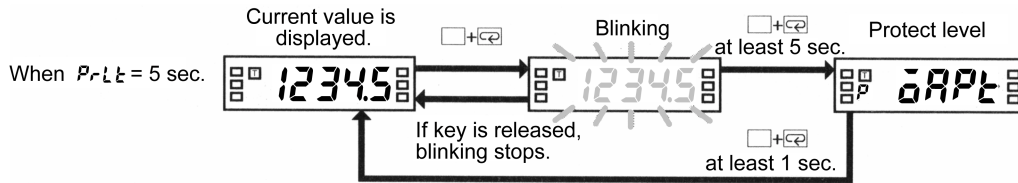

Procedure

TIPS

A move-to-protect-level time setting of "0" is assumed to be a setting of "1".

A. When the product is at the operation level, press the key and hold it down for at least three seconds to enter the initial setting level.

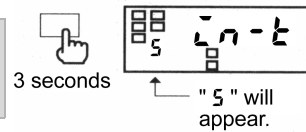

- "5" will appear on the level indicator, indicating the product has entered the initial setting level.

B. Enter password "-0169" in parameter "P-000" to enter the advanced-function setting level. For details on how to move to the advanced-function setting level, refer to "5-2 Moving among Levels".

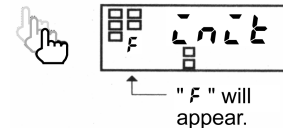

- "F" will appear on the level indicator, indicating the product has entered the advanced-function setting level.

C. Press the key several times until parameter "P-LLT" appears on the main indicator.

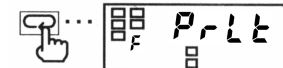

D. Press the key to display the set value of the parameter on the main indicator.

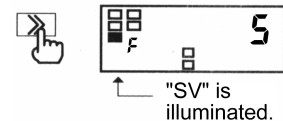

- The current set value of the move-to-protect-level time will appear on the main indicator.

E. Press the key again.

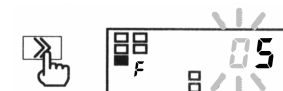

- The set value will start blinking, indicating the product is in the change state.

F. Use the  and  keys to change the set value.

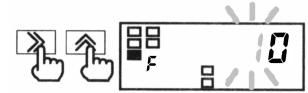

G. Press the  key to go to the next parameter.

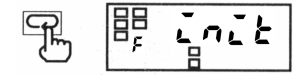

- The change is saved.

H. Press the  key and hold it down for at least one second to return to the initial setting level.



I. Press the  key and hold it down for at least one second to return to the operation level.



CHAPTER 6

FUNCTION DESCRIPTION

This chapter describes available functions of the product including measurement and average processing.

6-1	Measurement (K3MA-J)	6-2
	Voltage/Current Input/Scaling/Zero-limit/Forced-zero	
6-2	Measurement (K3MA-L)	6-5
	Temperature Input/Temperature Input Correction	
6-3	Measurement (K3MA-F)	6-6
	Pulse Input/Scaling/Auto-zero/Start-up Compensation Timer	
6-4	Average Processing	6-10
6-5	Comparative Output	6-11
6-6	Hysteresis	6-12
6-7	Display Color Change	6-13

6-1 Measurement (K3MA-J)

■ Voltage/Current Input

K3MA-J operates as a Process meter.

Measurements are made as follows.

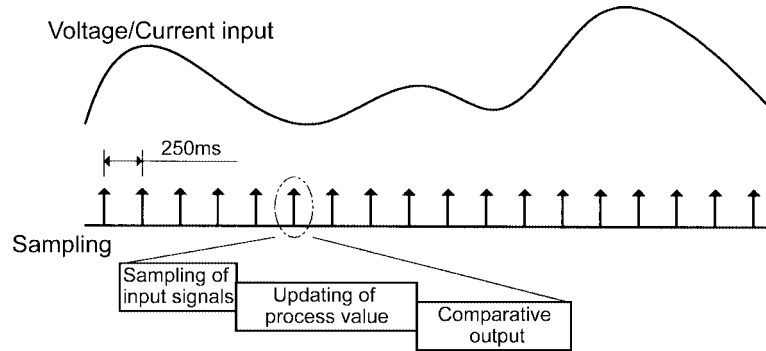

- Input signals are sampled in synchronization with internal timings generated at intervals of 250 ms.
- The input signal is scaled and the process value is updated according to the scaling result. The updated process value is displayed on the main indicator.
- Comparative output is provided based on the process value.
- The process value and comparative output are updated per sampling.

■ Scaling

Scaling is to convert sampled input values to process values in sequence using a predetermined scaling formula.

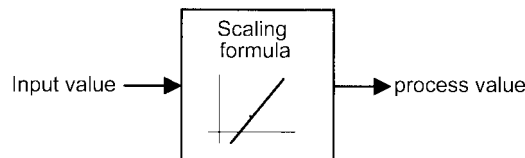

Scaling allows conversion of input values to process values in easy-to-understand notation.

The scaling formula for voltage and current input is as follows.

$$dsp = \frac{DSP2 - DSP1}{INP2 - INP1} inp + \frac{INP1 \cdot DSP2 - INP2 \cdot DSP1}{INP2 - INP1}$$

Where;

- INP1: Input value corresponding to process value DSP1
- DSP1: Process value corresponding to input value INP1
- INP2: Input value corresponding to process value DSP2
- DSP2: Process value corresponding to input value INP2
- inp: Input value sampled

dsp: Process value corresponding to inp

Enter INP1, DSP1, INP2 and DSP2 to specify the scaling factor.

This way of specifying the scaling factor permits flexible scaling; inverse scaling where the process value decreases with the increasing input value is also possible.

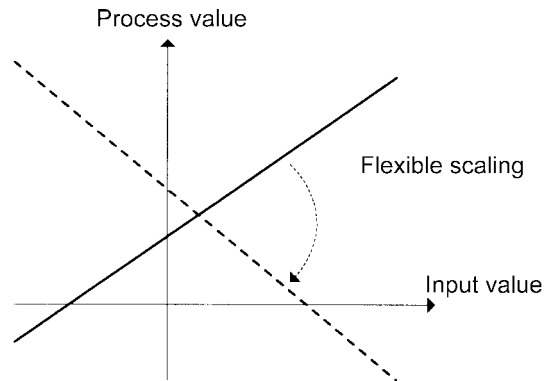

* For details on how to specify the scaling factor, refer to "5-12 Specifying the Scaling Factor (K3MA-J)".

■ Zero-limit

The zero-limit is a function to display all the readouts lower than a predetermined value as zero.

This is useful when you want to display a minus numerical value as zero or display a value in the vicinity of the minimum of input range as zero.

Digits of 00 to 99 can be set.

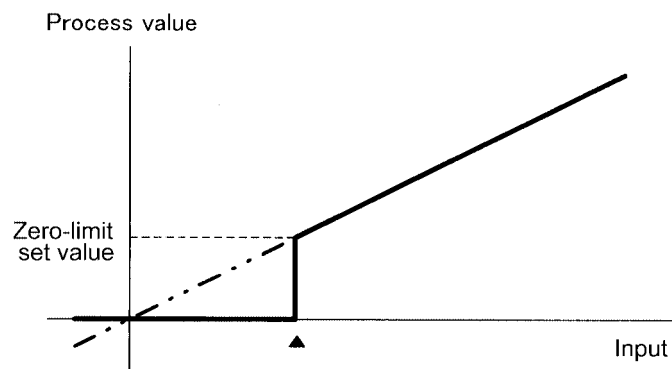





■ Forced-zero

This feature shifts a process value to zero forcedly, and can be used to evaluate and display the deviation of a process value from a reference value.

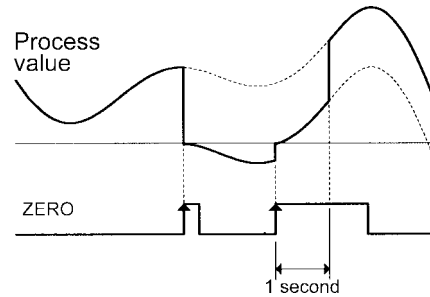
The forced-zero function can be activated by using  key on the front panel when a current value is displayed on the main indicator.

The following illustrates the forced-zero and forced-zero cancel operation.



- When the  key is pressed, the current process value is shifted to zero forcedly.
- Thereafter, measurements are made relative to the zero point.
- When the  key is pressed while the forced-zero function has been activated, the current process value is further shifted to zero.
- When the  key is pressed and held down for at least one second, the forced-zero operation is canceled.

Because the forced-zero and forced-zero cancel operation using the  key is stored in the internal nonvolatile storage of the product, the forced-zero state is alive even if the power turned off and on again.

6-2 Measurement (K3MA-L)

■ Temperature Input

K3MA-L operates as a Temperature meter.

Measurements are made as follows.

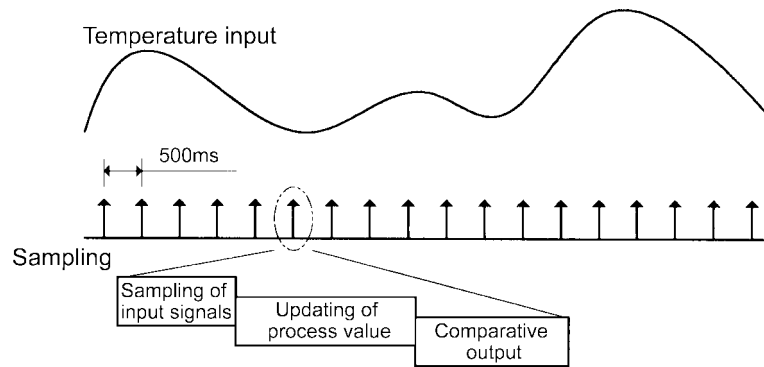

- Input signals are sampled in synchronization with internal timings generated at intervals of 500 ms.
- The input signal is scaled according to the sensor type and converted into temperature, and the process value is updated. The updated process value is displayed on the main indicator.
- Comparative output is provided based on the process value.
- The process value and comparative output are updated per sampling.

■ Temperature Input Correction

The input temperature is corrected by the quantity of the set value of "temperature input correction value" at all points in the whole sensor range.

If the correction value is 1.2 °C, the current value of 200 °C before correction will be processed as 201.2 °C after correction.

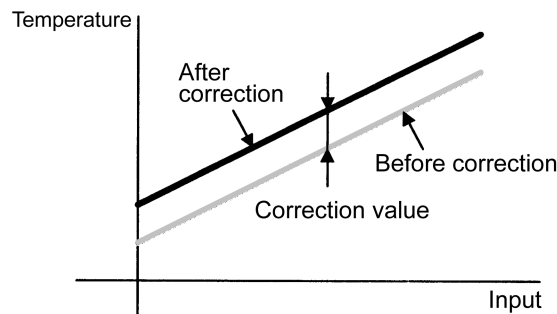

6-3 Measurement (K3MA-F)

■ Pulse Input

K3MA-F operates as a Frequency/Rate meter.

Measurements are made as follows.

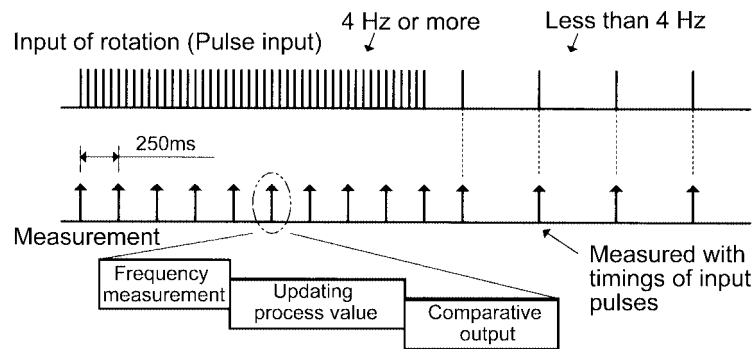

- When the input pulse frequency is 4 Hz or more, it is measured in synchronization with internal timings generated at intervals of 250 ms.
- The input pulse frequency is scaled and the process value is updated according to the scaling result.
- Comparative output is provided based on the process value.
- The process value and comparative output are updated at intervals of 250 ms.
- When the input pulse frequency is less than 4 Hz, it is measured with pulse input timings.
- Therefore, the intervals at which the process value and comparative output are updated lengthen in accordance with the decreasing input pulse frequency.

Minimum Pulse Width For pulse input, devices of low-speed contact output type or high-speed transistor output type can be connected to the terminal depending on parameter setting.

When using a device of low-speed contact output type, set the input pulse frequency to "30 Hz". To remove chattering noise when the input pulse frequency is "30 Hz", both ON and OFF pulses must have at least 15 ms in width.

When using a device of high-speed transistor output type, set the input pulse frequency to "5 kHz". In this case, both ON and OFF pulses must have at least 90 μ s in width.

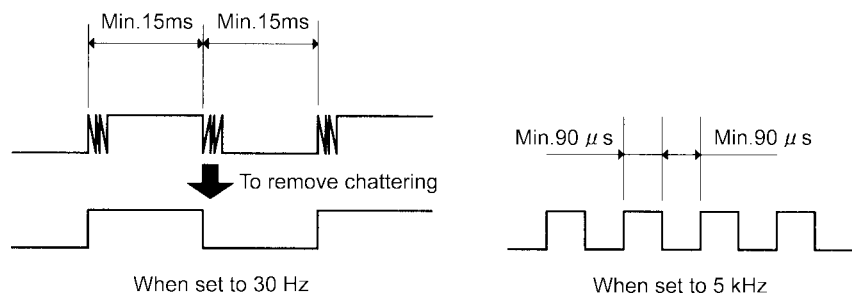

■ Scaling

Scaling is to convert sampled input values to process values in sequence using a predetermined scaling formula.

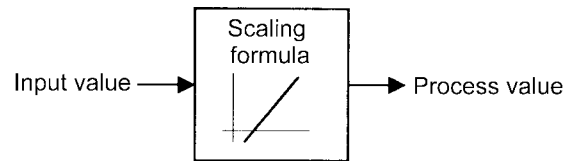

Scaling allows conversion of input values to process values in easy-to-understand notation.

The scaling formula for pulse input is as follows.

$$dsp = \frac{DSP}{INP} inp$$

Where;

INP: Input pulse frequency (Hz) corresponding to process value DSP

DSP: Process value corresponding to input pulse frequency INP

inp: Input pulse frequency (Hz)

dsp: Process value corresponding to inp

Enter INP and DSP to specify the scaling factor.

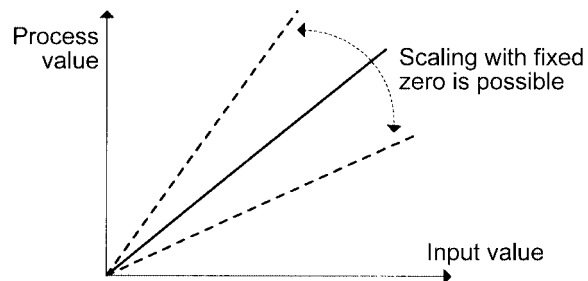

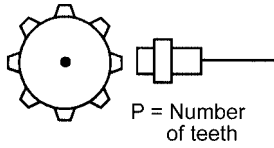

NOTE
Unit conversion
(r/s): (r/min)÷60

Conversion of the input pulse frequency to the rotational speed involves the following scaling formula.

$$dsp(r/min) = \frac{60}{P} inp$$

Where;

- P: Number of pulses per rotation
- inp: Input pulse frequency (Hz)
- dsp: Rotational speed (r/min)

Conversion of the input pulse frequency to the circumferential speed involves the following scaling formula.

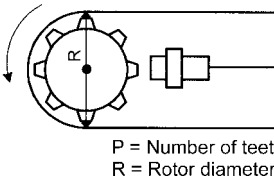

NOTE
Unit conversion
(m/s): (m/min)÷60
(mm/s): (m/min)×1000÷60

$$dsp(m/min) = \pi \cdot R \cdot \frac{60}{P} inp$$

Where;

- π : Circular constant
- P: Number of pulses per rotation
- R: Diameter of rotor (m)
- inp: Input pulse frequency (Hz)
- dsp: Circumferential speed (m/min)

■ Auto-zero

K3MA-F has an input pulse frequency range of 0.05 to 30 Hz or 0.05 to 5 kHz, and hence the maximum interval between pulses is 20 seconds.

This means that the product may provide a lower-limit signal action as late as a maximum of 20 seconds after receiving the last pulse, which results in a poor responsibility for the lower-limit action.

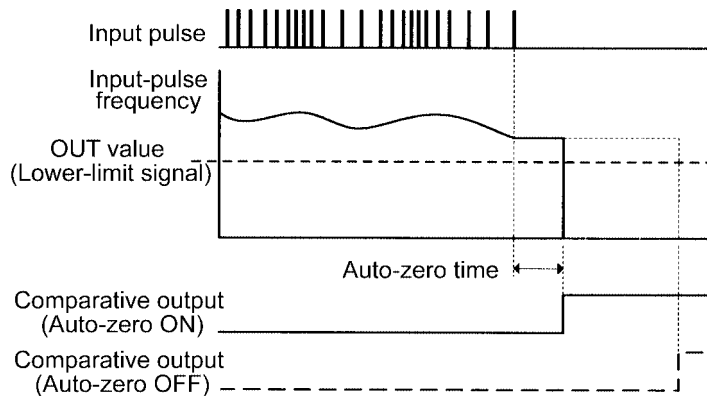

To eliminate such a situation, K3MA-F has an **auto-zero** function that shifts the input pulse frequency to zero forcedly when no pulse is received for a predetermined time.

This function improves the product responsibility for the lower-limit action.

The time between reception of the last impulse and zero-shifting of the input pulse frequency is called the auto-zero time. The auto-zero time can be specified using the "auto-zero time" parameter. Specify the auto-zero time somewhat longer than the expected longest interval between input pulses.

■ Start-up Compensation Timer

K3MA-F has a start-up **compensation timer** that prevents measurement for a predetermined time after power-on.

This function is useful in keeping the product in wait state until a rotor reaches the steady state speed when the product and the rotator have been powered on simultaneously.

The time between power-on of the product and the start of measurement can be specified using the "start-up compensation time" parameter.

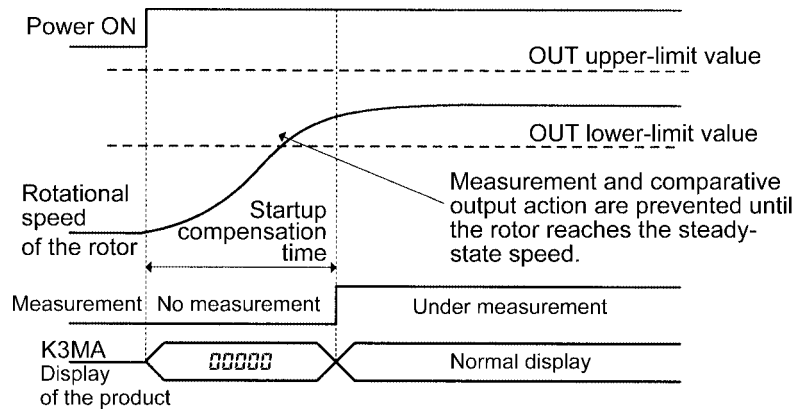

6-4 Average Processing

This function averages a specified number of measurements.

It is useful for preventing readout from fluctuating due to unstable input such as spike noise.

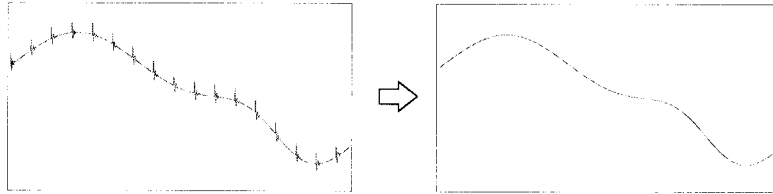

The average processing of the K3MA provides a simple average (an arithmetic mean).

The number of measurements for averaging that can be specified is as follows.

- No average processing (the number of measurements for averaging: 1)
- 2
- 4
- 8

The *number* of measurements for averaging is the number of times the process value is updated as described in "Measurement".

The following shows the relationship between the number of measurements for averaging and the interval at which the process value and comparative output are updated.

Number of measurements for averaging	Update interval			
	K3MA-J	K3MA-L	K3MA-F	
			Input pulse 4 Hz and more	Input pulse Less than 4 Hz
No average processing	250 ms	500 ms	250 ms	Every input pulse
2	500 ms	1 second	500 ms	Every 2 input pulses
4	1 second	2 seconds	1 second	Every 4 input pulses
8	2 seconds	4 seconds	2 seconds	Every 8 input pulses

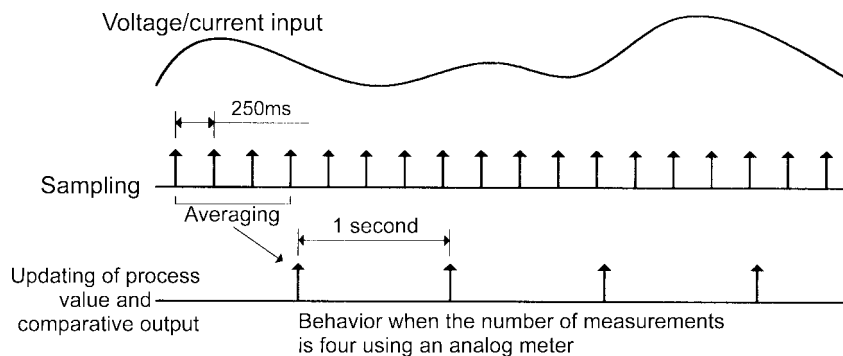

6-5 Comparative Output

Comparative outputs 1 and 2 can be produced as three types of signal actions: upper-limit signal action, lower-limit signal action, and outside-the-range signal action.

Upper-limit Action

Comparative output turns on when the process value reaches the OUT set value.

Comparative output turns off when the process value decreases to (OUT set value - hysteresis).

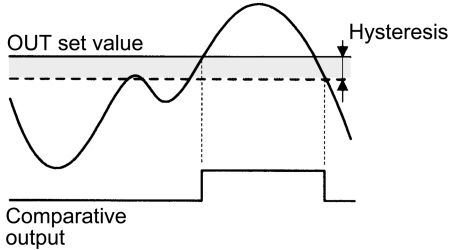

Lower-limit Action

Comparative output turns on when the process value decreases to the OUT set value.

Comparative output turns off when the process value reaches (OUT set value + hysteresis).

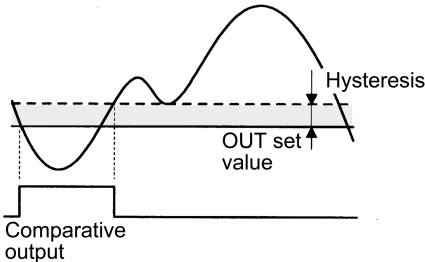

Outside-the-range Action

Comparative output turns on when the process value reaches the OUT upper-limit value or decreases to the OUT lower-limit value.

Comparative output turns off when the process value falls inside the range of (OUT upper-limit value - hysteresis) to (OUT lower limit value + hysteresis).

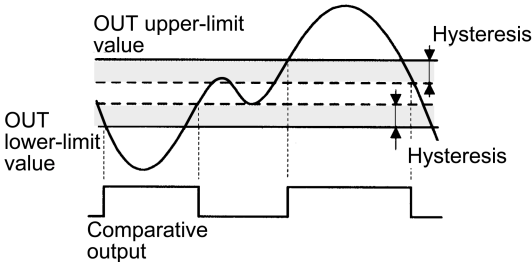

Combinations of comparative output 1 and 2 offer the possibility of producing a wide variety of actions including upper-limit + another upper-limit actions, lower-limit + another lower-limit actions, and two-level outside-the-range actions.

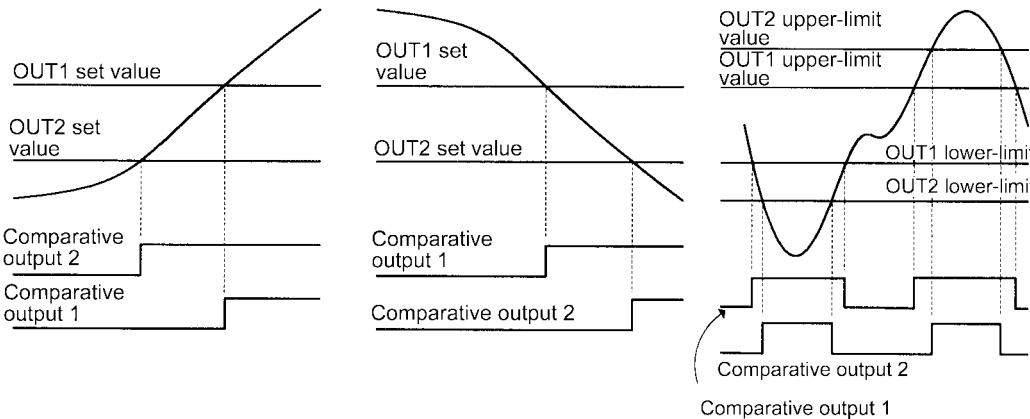

FUNCTION DESCRIPTION

6-6 Hysteresis

In this manual, **hysteresis** refers to a range that is provided above or below an OUT set value to avoid comparative output from turning off unless the process value falls outside the range, once the comparative output has turned on at the OUT set value.

Specifying the hysteresis suppresses chattering of comparative output caused by fluctuations of the process value in the vicinity of OUT set value.

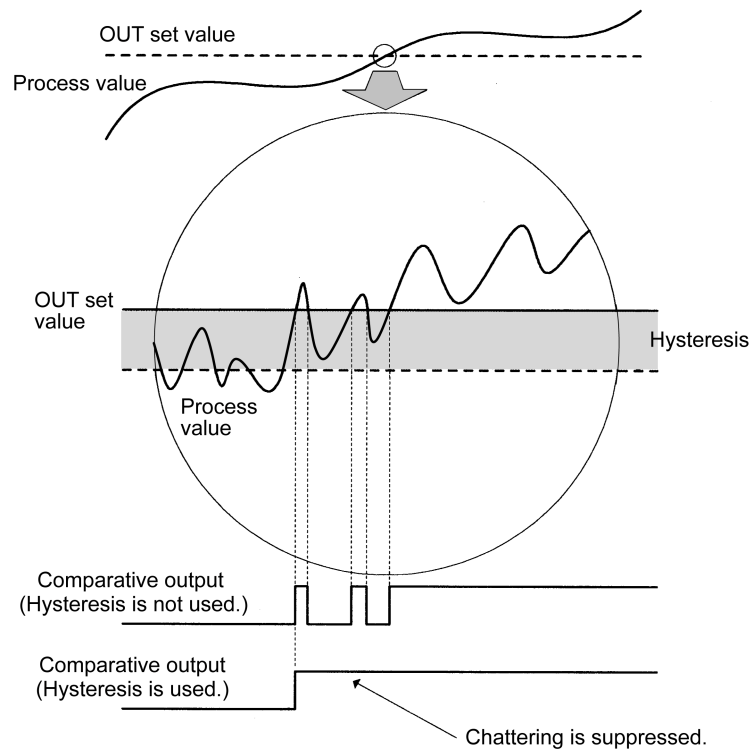

Comparative output ON/OFF conditions are as follows.

- Upper-limit action

ON: Process value \geq OUT set value

OFF: Process value \leq OUT set value - Hysteresis

- Lower-limit action

ON: Process value \leq OUT set value

OFF: Process value \geq OUT set value + Hysteresis

Hysteresis can be set to a desired value using parameter "hysteresis".

6-7 Display Color Change

The display color of the main indicator can be changed.

This feature can be used to vary the display color of the gang-mounted products depending on their importance or to greater prominence to indication on the main indicator of certain products in an emergency.

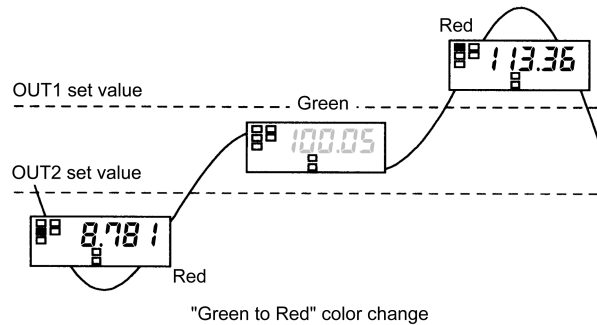

Four display color change options are available.

- Green to red: The display color of the main indicator is green when both of comparative outputs 1 and 2 are off, and changes to red when either of the comparative outputs turns on.
- Always green: The display color is always green.
- Always red: The display color is always red.
- Red to green: The display color is red when both of comparative outputs 1 and 2 are off, and changes to green when either of comparative outputs turns on.

CHAPTER 7

TROUBLESHOOTING GUIDE



This chapter describes malfunctions and troubles of the product, and how to deal with these problems.

7-1	Indication of Error	7-2
7-2	Troubleshooting Table	7-3

7-1 Indication of Error

Level indicator	Main indicator	Error description	Remedy
Off	E111	Internal storage is out of order.	Repair of the product is necessary. Contact a branch office of the company.
5	E111	Nonvolatile storage is out of order.	Repair of the product is necessary. Contact a branch office of the company.
Off	5Err blinking	The current range of 4 to 20 mA is selected for K3MA-J in the factory. Therefore, when the product is powered on for the first time after installation, and if nothing is connected to the current input terminals, this state will occur because of the input of 0 mA.	At the initial setting level, specify an appropriate input type in accordance with the application.
		Input is abnormal.	(K3MA-J) Supply voltage/current inputs that fall within the measuring range. The measuring range of each input type is as follows. 0-20 mA range: -2-22 mA 4-20 mA range: 2-22 mA 0-5 V range: -0.5-5.5 V 1-5 V range: 0.5-5.5 V ±5 V range: -5.5-5.5 V ±10 V range: -11-11 V If the product does not return to normal, repair of the product is necessary. Contact a branch office of the company.
			(K3MA-L) Check the incorrect wiring, disconnection, and short of the input, and input type. If the product does not return to normal, repair of the product is necessary. Contact a branch office of the company.
Off	99999 blinking	The scaled process value is higher than 99999. (For K3MA-L: 9999)	Supply input values that fall within allowable range. The scaling factor may be inappropriate. Review the scaling factor again at the initial setting level.
Off	-19999 blinking	The scaled process value is less than -19999. (For K3MA-L: -1999)	Supply input values that fall within allowable range. The scaling factor may be inappropriate. At the initial setting level, review the scaling factor again.

7-2 Troubleshooting Table

Symptom	Item to be checked	Remedy	Reference page
The forced-zero function is inoperative even though the  key is pressed.	Check if the forced-zero lockout is active.	At the protect level, set the forced-zero lockout to "Enable".	5-12
The product does not enter the protect level even though the  +  keys are held down for five seconds.	Check the specified value of parameter "move-to-protect-level time".	The time required for moving to the protect level can be changed by this parameter. Set it to an appropriate value.	5-35
Readouts vary greatly or decreases with increasing rotational speed. (K3MA-F)	Check if the set value of parameter "input-pulse frequency" is "30 Hz"?	When the input pulse is higher than 30 Hz, set the set value of this parameter to "5 kHz".	5-16
	Check if the pulse frequency of input pulse is higher than 5 kHz.	Return the input pulse frequency to within measuring range. Note that K3MA does not generate an "outside-of-measuring-range" error even if the input pulse frequency exceeds 5 kHz.	
Readouts vary or are incorrect even when the rotational speed is low. (K3MA-F)	Check if the pulse width of ON/OFF signals meets the specification.	The product can not recognize input pulses correctly unless their width is as specified, even if the rotational speed is low. Supply the product with pulses that have a width specified in this manual.	6-6
The main indicator reads "0" when the rotational speed is low. (K3MA-F)	Check if the set value of parameter "auto-zero time" is larger than the maximum time interval of input pulses.	Set this parameter to a larger value than the maximum time interval of input pulses.	5-28
		Otherwise, auto-zero functions to shift the readout to zero.	6-6
The product continues to read "00000" on the main indicator since powered on. (K3MA-F)	Check if the set value of parameter "startup compensation time" is too long.	Set the set value of this parameter to an appropriate value.	5-30
		In K3MA-J, the startup compensation time can be set to up to 99 seconds.	6-9
Comparative output does not turn off even when a process value goes back to normal.	Check if the set value of parameter "hysteresis" is too large.	Set this set value to an appropriate value.	5-27
			6-12



APPENDIX



Specifications	A-2
Parameter List	A-5

Specifications

Ratings

Supply voltage	100 to 240VAC(50/60Hz), 24VAC(50/60Hz)/DC
Operating voltage range	85% to 110% of the rated supply voltage
Power consumption	100 to 240VAC: 6 VA max. 24VAC/DC: 4.5 VA/W max. (at max. Load)
Insulation resistance	20 MΩ min. (with 500 V megger) Between all the external terminals and the case Insulation provided between inputs, outputs, and power supply.
Dielectric withstand voltage	2000VAC 1min Between all the external terminals and the case Insulation provided between inputs, outputs, and power supply.
Noise immunity	±1,500 V on AC power supply terminals in normal or common mode, ±480 V on AC/DC power supply terminals in normal or common mode, ±1 μs, or 100 ns for square-wave noise with 1 ns
Vibration resistance	Frequency: 10 to 55 Hz Acceleration: 50 m/s ² X,Y,Z direction 5 min×10 sweeps
Shock resistance	150 m/s ² (Relay contact: 100 m/s ²) 3 axes 6 directions × 3 times
Input impedance (Typ)	Voltage range : 1 MΩ min. Current range : 45 Ω max.
Input absolute maximum rating	±30 mA (4 to 20 mA, 0 to 20 mA) ±13.5 V (1 to 5 V, 0 to 5 V, ±5 V) ±26 V (±10 V)
Ambient temperature	-10 to +55°C (with no condensation or icing)
Ambient humidity	25 to 85%
Storage temperature	-25 to 65°C (with no condensation or icing)
Altitude	2,000 m max.
Weight	Approximately 200g *[J/L] / 220g *[F] (main body)

*[J]:K3MA-J, [L]:K3MA-L, [F]:K3MA-F

Relay Contact Output

(A2 Type)

Item	Resistive load(cos φ=1)	Inductive load(cos φ=0.4, L/R=7ms)
Rated load	250VAC 5A, 30VDC 5A	250VAC 1A, 30VDC 1A
Rated carry current	5A max. (at COM terminal)	
Max. contact voltage	250VAC, 150VDC	
Max. contact current	5A max. (at COM terminal)	
Max. switching capacity	1250VA, 150W	250VA, 30W
Min. permissible load	5VDC, 10mA	
Mechanical life	5,000,000 times min. (at a switching frequency of 1,200 times/min)	
Electrical life (at an ambient temperature of 20°C)	100,000 times min. (at a rated load switching frequency of 10 times/min)	

(C Type)

Item	Resistive load(cos φ=1)	Inductive load(cos φ=0.4, L/R=7ms)
Rated load	250VAC 5A, 30VDC 5A	250VAC 1.5A, 30VDC 1.5A
Rated carry current	5A max. (at COM terminal)	
Max. contact voltage	400VAC, 150VDC	
Max. contact current	5A max. (at COM terminal)	
Max. switching capacity	2000VA, 192W	375VA, 36W
Min. permissible load	5VDC, 10mA	
Mechanical life	20,000,000 times min. (at a switching frequency of 1,200 times/min)	
Electrical life (at an ambient temperature of 20°C)	100,000 times min. (at a rated load switching frequency of 10 times/min)	

Characteristics

A/D conversion method	Double integral method
Sampling period	250 ms *[J], 500 ms *[L]
Max. displayd digits	-19999 to 99999 *[J/F] / -1999 to 9999 *[L]
Average processing	Simple average of None/2/4/8 measurements
Comparative output	1a × 2 *[J/F] / 1c *[L] (Relay contact output)
Delay in comparative output	750ms max. *[J/F] / 1s max. *[L]
Other functions	Display color change Key protect Startup compensation timer (Only K3MA) Auto-zero (Only K3MA) Switching of comparative outputs
Enclosure ratings	Front side: NEMA4X(equivalent to IP66) Rear case: IP20 Terminal area: IP00+Finger Protection(VDE106/part100) when the terminal cover is mounted.
Memory protection	EEPROM (Nonvolatile storage) Saving times: one hundred thousand times
Ambient atmosphere	Installation categoryII, Degree of contamination : 2 (according to IEC61010-1)
Approved standards	UL3121,CSA C22.2 No.14 EN61010-1(IEC61010-1):"pollution degree 2,overvoltage category II" EN61326+A1 Industrial use "Class A" (EMI) Emission Enclosure: CISPR11 Group1 Class A:CISPR16-1/-2 Emission AC Mains: CISPR11 Group1 Class A:CISPR16-1/-2 (EMS) Immunity ESD: EN61000-4-2: 4-kV contact discharge 8-kV air discharge Immunity-RF-interference: EN61000-4-3: 10 V/m(amplitude modulated, 80MHz to 1GHz) Immunity Burst: EN61000-4-4: 2-kV power line 1-kV I/O signal-line Immunity Surge: EN61000-4-5: 1kV (L-N/AC Lines) 2kV(L-PE,N-PE/AC Lines) Immunity Conducted Disturbance: EN61000-4-6: 3 V(0.15 to 80 MHz) Immunity Voltage interrupts: EN61000-4-11:0.5Cycle,0°,180°,100%(rated voltage)

*[J]:K3MA-J, [L]:K3MA-L, [F]:K3MA-F

Input Characteristics

K3MA-J

Input type	Setting range	Control range	Measuring accuracy
0-20	0 to 20mA	-2 to 22mA	±0.1%FS±1digit max. at 23°C±3°C
4-20	4 to 20mA	2 to 22mA	
0-5	0 to 5V	-0.5 to 5,5V	
1-5	1 to 5V	0.5 to 5.5V	
5	±5V	±5.5V	±0.1%FS±1digit max. at 23°C±5°C
10	±10V	±11V	

K3MA-L

Input type	Set value	Setting range	Control range	Indication accuracy	
Platinum resistance thermometer	Pt100	0	-200 to 850°C -300 to 1500°F	-220 to 870°C -340 to 1540°F	±0.5% of indicated value or ±1°C, whichever is larger ±1digit max.
		1	-199.9 to 500.0°C -199.9 to 900.0°F	-199.9 to 520.0°C -199.9 to 940.0°F	
		2	0.0 to 100.0°C 0.0 to 210.0°F	-20.0 to 120.0°C -40.0 to 250.0°F	
	JPt100	3	-199.9 to 500.0°C -199.9 to 900.0°F	-199.9 to 520.0°C -199.9 to 940.0°F	
		4	0.0 to 100.0°C 0.0 to 210.0°F	-20.0 to 120.0°C -40.0 to 250.0°F	
Thermocouple	K	5	-200 to 1300°C -300 to 2300°F	-220 to 1320°C -340 to 2340°F	±0.5% of indicated value or ±1°C, whichever is larger ±1digit max. (at a temperature of -100°C or less: ±2°C±1digit max.)
		6	-20.0 to 500.0°C 0.0 to 900.0°F	-40.0 to 520.0°C -40.0 to 940.0°F	±0.5% of indicated value or ±1°C, whichever is larger ±1digit max.
	J	7	-100 to 850°C -100 to 1500°F	-120 to 870°C -140 to 1540°F	
		8	-20.0 to 400.0°C 0.0 to 750.0°F	-40.0 to 420.0°C -40.0 to 790.0°F	
	T	9	-200 to 400°C -300 to 700°F	-220 to 420°C -340 to 740°F	±0.5% of indicated value or ±1°C, whichever is larger ±1digit max. (at a temperature of -100°C or less: ±2°C±1digit max.)
		10	-199.9 to 400.0°C -199.9 to 700.0°F	-199.9 to 420.0°C -199.9 to 740.0°F	
	E	11	0 to 600°C 0 to 1100°F	-20 to 620°C -40 to 1140°F	±0.5% of indicated value or ±1°C, whichever is larger ±1digit max.
	L	12	-100 to 850°C -100 to 1500°F	-120 to 870°C -140 to 1540°F	±2°C±1digit max.
	U	13	-200 to 400°C -300 to 700°F	-220 to 420°C -340 to 740°F	
		14	-199.9 to 400.0°C -199.9 to 700.0°F	-199.9 to 420.0°C -199.9 to 740.0°F	
	N	15	-200 to 1300°C -300 to 2300°F	-220 to 1320°C -340 to 2340°F	±0.5% of indicated value or ±1°C, whichever is larger ±1digit max. (at a temperature of -100°C or less: ±2°C±1digit max.)
	R	16	0 to 1700°C 0 to 3000°F	-20 to 1720°C -40 to 3040°F	±0.5% of indicated value or ±1°C, whichever is larger ±1digit max. (at a temperature of 200°C or less: ±3°C±1digit max.)
	S	17	0 to 1700°C 0 to 3000°F	-20 to 1720°C -40 to 3040°F	
B	18	100 to 1800°C 300 to 3200°F	0 to 1820°C 0 to 3240°F	±0.5% of indicated value or ±1°C, whichever is larger ±1digit max. (at a temperature of 400°C or less is unrestricted.)	

K3MA-F

Pulse frequency	Setting range	Measuring accuracy
30	0.05 to 30Hz (Minimum pulse width: 15ms)	±0.1%FS±1digit max. at 23°C±5°C
5k	0.05 to 5kHz (Minimum pulse width: 90µs)	

Parameter List

Use this list to note your set values.

K3MA-J

Level	Parameter	Indication	Setting range	Default	Unit	Set value
Protect	Operation/adjustment lockouts	ᄁᄁᄁᄁ	0-2	0		
	Setting level lockout	ᄁᄁᄁᄁ	0-2	1		
	Setting change lockout	ᄁᄁᄁᄁ	ᄁᄁᄁ/ᄁᄁ	ᄁᄁᄁ		
	Forced-zero lockout	ᄁᄁᄁᄁ	ᄁᄁᄁ/ᄁᄁ	ᄁᄁ		
Operation	OUT1 Value	ᄁᄁᄁ 1	-9999-99999	99999		
	OUT1 upper-limit value	ᄁᄁᄁ 1H	-99999-999999	999999		
	OUT1 lower-limit value	ᄁᄁᄁ 1L	-999999-999999	-999999		
	OUT2 value	ᄁᄁᄁ 2	-99999-999999	-999999		
	OUT2 upper-limit value	ᄁᄁᄁ 2H	-999999-999999	999999		
	OUT2 lower-limit value	ᄁᄁᄁ 2L	-999999-999999	-999999		
Initial setting	Input type	ᄁᄁ-ᄁ	0-20/4-20/0-5/1-5/5/10	4-20		
	Scaling input value 1	ᄁᄁᄁ.1	-99999-999999	4.00		
	Scaling display value 1	ᄁᄁᄁ.1	-999999-999999	400		
	Scaling input value 2	ᄁᄁᄁ.2	-999999-999999	20.00		
	Scaling display value 2	ᄁᄁᄁ.2	-999999-999999	2000		
	Decimal point position	ᄁᄁ	0.0000/00.000/000.00/0000.0/00000	000.00		
	OUT1 type	ᄁᄁᄁ 1ᄁ	Hᄁ/Lᄁ/Hᄁ-Lᄁ	Hᄁ		
	OUT2 type	ᄁᄁᄁ 2ᄁ	Hᄁ/Lᄁ/Hᄁ-Lᄁ	Lᄁ		
Move to advanced-function setting level	ᄁᄁᄁᄁ	-99999-999999	0			
Advanced-function setting	Parameter initialization	ᄁᄁᄁᄁ	ᄁᄁᄁ/ᄁᄁ	ᄁᄁᄁ		
	No. of measurements for averaging	ᄁᄁᄁ	ᄁᄁᄁ/2/4/8	ᄁᄁᄁ	time	
	OUT1 hysteresis	Hᄁᄁ 1	0-9999	1		
	OUT2 hysteresis	Hᄁᄁ 2	0-9999	1		
	Zero-limit	ᄁᄁ-Lᄁᄁ	ᄁᄁᄁ/ᄁᄁ	ᄁᄁᄁ		
	Zero-limit value	Lᄁᄁ-P	0-99	0		
	Display color change	Lᄁᄁᄁ	ᄁᄁᄁ-ᄁ/ᄁᄁᄁ/ᄁᄁᄁ-ᄁ/ᄁᄁᄁ	ᄁᄁᄁ-ᄁ		
	Display auto-return time	ᄁᄁᄁ	0-99	10	s	
	Move-to-protect-level time	Pᄁᄁᄁ	0-19	5	s	

K3MA-L

Level	Parameter	Indication	Setting range	Default	Unit	Set value	
Protect	Operation/adjustment lockouts	ðAPt	0-2	0			
	Setting level lockout	ÿCPt	0-2	1			
	Setting change lockout	ÿtPt	ðFF/ðn	ðFF			
Operation	OUT1 value	ðUt 1	-9999-9999	9999			
	OUT1 upper-limit value	ðUt 1H	-9999-9999	9999			
	OUT1 lower-limit value	ðUt 1L	-9999-9999	-9999			
Adjustment	Temperature input correction value	ÿnS	-9999-9999	0			
Initial setting	Input type	ÿn-t	Resistance thermometer	0: Pt100 1: Pt100 2: Pt100 3: JPt100 4: JPt100	S		
			Thermocouple	5: K 6: K 7: J 8: J 9: T 10: T 11: E 12: L 13: U 14: U 15: N 16: R 17: S 18: B			
	Temperature unit	d-U	ÿ/F	ÿ			
	OUT1 type	ðUt 1t	Hÿ/Lð/Hÿ-Lð	Hÿ			
	Move to advanced-function setting level	Rñðu	-9999-9999	0			
	Parameter initialization	ÿnÿt		ðFF/ðn	ðFF		
	Advanced-function setting	No. of measurements for averaging	RuG	ðFF/2/4/8	ðFF	time	
OUT1 hysteresis		HYS 1	0-9999	1			
Display color change		ÿðLðr	ÿrn-r/ÿrn/rEd-ÿ/rEd	ÿrn-r			
Display auto-return time		rEt	0-99	10	s		
Move-to-protect-level time		PrLt	0-19	5	s		

K3MA-F

Level	Parameter	Indication	Setting range	Default	Unit	Set value
Protect	Operation/adjustment lockouts	OPPL	0-2	0		
	Setting level lockout	SLPL	0-2	1		
	Setting change lockout	YPL	OFF/ON	OFF		
Operation	OUT1 Value	OUT1	-9999-99999	99999		
	OUT1 upper-limit value	OUT1H	-9999-99999	99999		
	OUT1 lower-limit value	OUT1L	-9999-99999	-99999		
	OUT2 value	OUT2	-9999-99999	-99999		
	OUT2 upper-limit value	OUT2H	-9999-99999	99999		
	OUT2 lower-limit value	OUT2L	-9999-99999	-99999		
Initial setting	Pulse frequency	P-FrE	30/5μ	5μ	Hz	
	Scaling input value	SNP	0-99999	5000		
	Scaling display value	dSP	-99999-99999	5000		
	Decimal point position	dP	0.0000/00.000/000.00/0000.0/00000	00000		
	OUT1 type	OUT1t	H/L/0/H-L/0	H/L		
	OUT2 type	OUT2t	H/L/0/H-L/0	L/0		
	Move to advanced-function setting level	ANOU	-9999-99999	0		
Advanced-function setting	Parameter initialization	INLT	OFF/ON	OFF		
	No. of measurements for averaging	AVG	OFF/2/4/8	OFF	time	
	OUT1 hysteresis	HYS1	0-9999	1		
	OUT2 hysteresis	HYS2	0-9999	1		
	Auto-zero time	AUTZ	0.0-19.9	19.9	s	
	Startup compensation timer	S-tAr	0.0-99.9	0.0	s	
	Display color change	CLOR	Grn-r/Grn/rEd-0/rEd	Grn-r		
	Display auto-return time	rEt	0-99	10	s	
	Move-to-protect-level time	PrLt	0-19	5	s	

INDEX

A

absolute maximum rating..... 2-6
adapter..... 2-2
adjustment..... 5-2
adjustment level..... 5-3
advanced-function setting..... 5-2
advanced-function setting level..... 5-4
alphabets..... 5-6
analog input..... 1-5
auto-zero..... 6-8,5-28
auto-zero time..... 5-28
average processing..... 6-10

C

change state..... 5-6
comparative output..... 1-3,2-5,6-11
contact output..... 1-6
crimp contact type terminals..... 2-5
current leakage with transistor turned ON..... 2-6

D

decimal point position..... 5-22
digital panel meter..... 1-2
dimensions..... 2-2
display auto-return time..... 5-34
display color..... 1-3,5-33
display color change..... 6-13

F

forced-zero..... 5-9,6-4
forced-zero lockout..... 5-12

H

hysteresis..... 5-27,6-12
hysteresis (width)..... 6-12

I

I/O circuit..... 1-5
I/O terminal connections..... 2-4
Indication of error..... 7-2

initial setting..... 4-1,5-2
initial setting level..... 5-3
initialize all parameters..... 5-25
input circuit diagrams..... 1-5
input range over..... 4-2
input type..... 5-14
installation..... 2-2
installation procedure..... 2-3
internal block diagram..... 1-6
internal nonvolatile storage..... 6-4

K

key protect..... 5-12

L

level..... 5-2
load..... 2-5
lower-limit signal action..... 3-3,3-5,3-9,3-11,6-11

M

main features..... 1-2
measurement..... 6-2
min. load current..... 2-6
model number legend..... 1-4
monitor state..... 5-6
move-to-protect-level time..... 5-35

N

number of measurements for averaging..... 5-26,6-10
numerics..... 5-6

O

OFF leakage current..... 2-6
OFF pulse width..... 6-6
ON pulse width..... 6-6
ON residual voltage..... 2-6
operation..... 5-2
operation/adjustment lockouts..... 5-12
OUT1 lower-limit value..... 5-8
OUT1 upper-limit value..... 5-8

OUT1 value..... 5-8
 OUT2 lower-limit value..... 5-8
 OUT2 upper-limit value..... 5-8
 OUT2 value..... 5-8
 output circuit diagrams 1-6
 outside-the-range signal action 3-7,6-11

P

panel cutout dimensions..... 2-2
 parameter..... 5-5
 password 5-4
 power supply 2-5
 pressure sensor 3-4
 protect 5-2
 protect level..... 5-3
 proximity switch 3-8
 pulse frequency 5-16
 pulse input..... 1-5,2-6,6-6

R

remove chattering..... 6-6

S

sampling 6-2,6-5
 scaling 1-2,6-2,6-7
 scaling factor..... 5-17,5-19
 scaling formula..... 6-2,6-7
 scaling operation error 5-21

selecting a comparative output..... 5-24
 set values 5-6
 setting change lockout..... 5-12
 setting level lockout 5-12
 shift..... 1-3
 spike noise..... 6-10
 start-up compensation time 5-30
 start-up compensation timer 6-9
 supply capacity..... 2-5
 suppresses chattering..... 6-12

T

teaching function..... 5-18,5-20
 terminal arrangement 2-4
 terminal connection..... 2-5

U

ultrasonic displacement sensor..... 3-2
 upper-limit signal action 3-3,3-5,3-7,3-9,3-11,6-11

V

viewing and changing the OUT set values..... 5-7

W

waterproof 2-3
 watertight packing..... 2-3



OMRON ELECTRONICS LLC

1 Commerce Drive
Schaumburg, IL 60173 USA
800.55.OMRON (66766)

OMRON CANADA, INC.

885 Milner Avenue
Scarborough, Ontario M1B 5V8
416.286.6465

OMRON ON-LINE

Global - <http://www.omron.com>
USA - <http://www.omron.com/oei>
Canada - <http://www.omron.com/oci>

For Distributor Locations or Product Information, Call:

800.55.OMRON or 847.843.7900

UNITED STATES REGIONAL SALES OFFICES

Northeast	Boston, MA	508.303.8880
East	Philadelphia, PA	610.524.1897
Southeast	Atlanta, GA	770.798.6780
Central	Cincinnati, OH	513.469.6766
Midwest	Chicago, IL	847.843.7910
Southwest	Dallas, TX	972.871.2166
West	Los Angeles, CA	714.621.3455

CANADA REGIONAL SALES OFFICES

Ontario	Toronto	416.286.6465
	Kitchener	519.896.1144
	Kingston	613.376.3968
Quebec	Montreal	514.636.6676
	Ste-Foy	418.864.7378
British Columbia	Vancouver	604.522.8855
Alberta	Edmonton	403.440.0818
	Calgary	403.257.3095

BRAZIL SALES OFFICE

Sao Paulo 55.11.5564.6488

ARGENTINA SALES OFFICE

Buenos Aires 54.114.787.1129

MEXICO/LATIN AMERICA SALES OFFICE

Florida 954.227.2121